

Hako



Scrubmaster B400 R / RM / RH (7190)

Operating manual

Part number 88-10-3255 - 4480-00

Valid as from: 03.2021

Introduction

Foreword

We are certain that the excellent qualities of the machine will justify the faith you have shown in us by your purchase.

To guarantee safe working with the machine, please read the Safety Notes chapter before putting it into service.

Your own safety, as well as the safety of others, depends essentially on your ability to control the vehicle. Please read this **original operating manual** before you use the vehicle for the first time, act accordingly and keep these instructions for future reference or subsequent users. The operating manual contains all important information for operation, maintenance and servicing. We have provided the points in this operating manual concerning your safety with danger pictograms. Your authorised Hako dealer is available at all times to answer further questions about the vehicle or the operating manual.

We would expressly advise you that no legal claims may be asserted based on the contents of this operating manual. In the case of necessary repair work, please make sure that only original spare parts are used. Spare parts must be original spare parts to guarantee safety. We reserve the right to make changes in the interests of further technical development.

Hako GmbH
23843 Bad Oldesloe, Germany
Hamburger Str. 209-239
Phone +49 4531 806-0

Issue:

Index	Book number	Change no.	Valid as from:
0	88-10-3255	4480-00	03.2021

Intended use

In the basic variant B400 R, the Scrubmaster is just a scrubber-drier for the wet cleaning of hard indoor floor surfaces. This machine is intended for commercial use, e.g. in shopping centres, airports, industrial plants and warehouses. In the variants B400 RM and B400 RH, the Scrubmaster also has a sweeping function for picking up dry and moist dirt. These two variants are additionally intended for use in multi-storey car parks, pedestrian zones and car parks, for example. Any use extending beyond this is not intended use. The manufacturer is not liable for any damage resulting from this; the operator alone bears the risk. Intended use also includes compliance with the operating, maintenance and repair conditions specified by the manufacturer in this operating manual. The Scrubmaster B400 R may be used, maintained and repaired only by persons who are familiar with this work and have been briefed and instructed about the dangers. Repairs and maintenance work not described in this operating manual may only be carried out by the specialists of a Hako service workshop.

The relevant accident prevention regulations as well as the other generally recognised safety engineering and occupational medical rules must be complied with.

By virtue of its design and construction as well as in the version distributed by us, the machine meets the usual health and safety requirements of the EC Directives (see Declaration of Conformity). This Declaration of Conformity loses its validity in the event of a modification to the machine not authorised by us. The manufacturer is not deemed liable for any damage resulting from unauthorised modifications to the machine.

Notes on warranty

The terms defined in the purchase agreement apply. Claims for compensation in relation to damage are excluded from the terms of the warranty when the damage is the result of the failure to observe rules concerning servicing and maintenance. Maintenance work must be carried out by a Hako service workshop and confirmed in the service booklet under the item "Maintenance Report". The service booklet serves as a warranty logbook.

The following are excluded from the terms of warranty: Natural wear and tear through overuse, defective fuses, improper handling, misuse and unauthorised modifications. Claims under the terms of the warranty are also annulled when damage occurs to the machine resulting from the use of parts or accessories not explicitly approved of by us or from failure to observe maintenance rules.

Acceptance of the machine

Inspect the machine immediately on delivery for signs of transport damage. You will be compensated for transport damage provided you immediately have the damage confirmed by the transport company and send in the damage report together with the consignment note to your Hako dealer:

Machine data

Your machine is described clearly by the following data. Please always quote these data in correspondence or when making a telephone query to your authorised Hako dealer or our company.

- Vehicle type: _____
- Vehicle ID no.: _____
- Start-up on: _____

Please enter the data applicable to your machine in the list above. The data is immediately available in the case of enquiries or spare parts orders.

Your nearest authorised Hako dealer:

- Address: _____

- Telephone: _____

	Introduction	2
	Foreword	2
	Intended use	3
	Acceptance of the machine	4
1	Safety instructions	10
1.1	Warning and danger symbols	10
1.2	Staff qualification	11
1.3	Protective equipment	12
1.4	General safety instructions	13
1.5	Operating safety instructions	14
1.5.1	General	14
1.5.2	Before putting into service	15
1.5.3	During operation	15
1.5.4	After operation	17
1.6	Maintenance instructions	18
1.7	Information about special risks	21
1.7.1	Electrical system	21
1.7.2	Batteries	21
1.7.3	Hydraulic system (B400 RH only)	22
1.8	Environmental protection instructions and disposal	23
1.9	Labels on the machine	24
2	Use	28
2.1	Overviews	28
2.1.1	Front view (B400 R)	28
2.1.2	Front view (B400 RM)	30
2.1.3	Front view (B400 RH)	32
2.1.4	Rear view	34
2.1.5	Control panel	36
2.2	Controls and display elements	38
2.2.1	Control panel	38
2.3	Multifunction display	47
2.3.1	Menu guidance	48
2.3.2	Main menu	48
2.3.3	Sub-menu	57
2.3.4	Controls at the machine	62
2.4	Functional description	66
2.4.1	Solution tank	67
2.4.2	Rotating brush unit	67
2.4.3	Squeegee	68
2.4.4	Waste water tank	68
2.4.5	Side wiper	69
2.4.6	Suction turbines	69
2.4.7	Travel drive	69

2.4.8	Brakes	70
2.4.9	Batteries	70
2.4.10	Sweeping roller (B400 RM/RH only)	70
2.4.11	Side broom (B400 RM/RH only)	71
2.4.12	Dirt hopper (B400 RM/RH only)	71
2.4.13	Filter system/Dust extraction system (B400 RM/RH only)	71
2.4.14	High-pressure cleaner (option)	72
2.4.15	Steering column switch StVZO (option)	72
2.4.16	Working light, reversing camera with monitor and flashlight (option)	73
3	Operation.....	74
3.1	Instruction	75
3.2	Before putting into service	75
3.3	Check list: Before machine start-up	76
3.3.1	Checking the working light, flashlight and warning device (option)	77
3.3.2	Checking the lighting system and horn (option)	78
3.3.3	Driver's seat	78
3.3.4	Steering wheel height adjustment (option)	80
3.3.5	Side mirror (option) adjustment	81
3.4	Cleaning	82
3.4.1	entry.X (option)	84
3.4.2	On-board dosing system (option)	85
3.4.3	Useful cleaning tips	87
3.4.4	Handling and braking the vehicle	88
3.4.5	Towing the machine	89
3.4.6	Turning off the machine	93
3.4.7	Check list: After cleaning	94
3.5	Loading and transporting	95
3.6	Service information	97
4	Technical data.....	100
5	Maintenance and servicing.....	106
5.1	Maintenance plan	108
5.2	Battery	111
5.2.1	Checking the charging state	111
5.2.2	Charging the battery	112
5.2.3	Checking the acid level	115
5.2.4	Changing the battery	116
5.2.5	Battery plug coding	119
5.2.6	Maintaining drive batteries	120
5.2.7	Taking the machine out of service for a long period ...	120
5.2.8	Disposing of batteries	120

5.3	Solution tank	120
5.3.1	Filling the solution tank	121
5.3.2	Emptying the solution tank	123
5.3.3	Cleaning the solution tank	124
5.3.4	Checking the seal at the drain hose	124
5.4	Waste water tank	125
5.4.1	Emptying the waste water tank	125
5.4.2	Cleaning the waste water tank	126
5.4.3	Cleaning the coarse dirt sieve	127
5.4.4	Cleaning the intake sieve	128
5.4.5	Checking the seal at the drain valve	128
5.4.6	Cleaning and checking the seal in the tank cap	129
5.5	Cleaning the fresh water filter	130
5.6	Rotating brush unit	132
5.6.1	Changing the rotating brushes/pads	132
5.6.2	Cleaning the rotating brushes	133
5.6.3	Decoupling the rotating brushes/pads	133
5.6.4	Coupling the rotating brushes/pads	134
5.7	Dirt hopper (B400 RM/RH only)	135
5.7.1	Emptying the dirt hopper (B400 RM only)	135
5.7.2	Emptying the dirt hopper (B400 RH)	136
5.8	Pre-sweep suction unit (B400 RM/RH only)	138
5.8.1	Changing the sweeping roller (B400 RM/RH only)	138
5.8.2	Cleaning the sweeping roller and the sweeping roller compartment	138
5.8.3	Removing the sweeping roller	139
5.8.4	Inserting the sweeping roller	140
5.8.5	Adjusting the sweeping level	141
5.9	Side broom (B400 RM/RH only)	142
5.9.1	Changing the side broom	142
5.9.2	Adjusting the side broom	143
5.10	Filter system/Dust extraction system (B400 RM/RH only)	144
5.10.1	Cleaning the plate filter	144
5.10.2	Basic cleaning of the plate filter	145
5.11	Squeegee	147
5.11.1	Cleaning the squeegee	147
5.11.2	Changing the sealing / slot strip	150
5.12	Side wiper	151
5.12.1	Changing the wiper rubber	151
6	Attachments/options	152
6.1	Light refuse collector (B400 R only)	152
6.2	Broom strip (B400 R only)	152
6.3	Mop strip (B400 R only)	152

6.4	Spray suction tool	153
6.5	Manual suction tool	155
6.6	Spray nozzle	156
6.7	Battery changing system	157
6.8	Overhead guard	162
6.9	BlueSpot	163
6.10	Reversing camera	164
6.11	StVZO	164
6.12	High-pressure cleaner	166



1 Safety instructions

1.1 Warning and danger symbols

Important tasks concerning the safety of the operating staff and machine are named as follows in this operating manual and emphasised by symbols.



Danger

Indication of a direct danger with high risk, in which death or severe physical injury occurs if the danger is not avoided.



Warning

Indication of a possible danger with average risk, in which death or severe physical injury can occur if the danger is not avoided.



Caution

Indication of a danger with low risk, in which light physical injury can occur if the danger is not avoided.



Attention

Attention indicates a danger that can lead to material damage or technical damage to the device when not observed.



Environmental danger

Environmental danger due to the use of substances from which a health and environmental risk proceeds.



Note

Indication of information that facilitates more effective and economical use of the machine.

1.2 Staff qualification

The various tasks described in this operating manual place different demands on the qualifications of the persons entrusted with these tasks.



Warning

Danger in case of insufficient qualification of persons!
Inadequately qualified persons cannot assess the risks involved in handling the vehicle and expose themselves and others to the risk of severe or fatal injury.

- All work must only be carried out by qualified persons.

All work on and with the machine may only be carried out by qualified and authorised staff. Staff are qualified if they have been trained, briefed or instructed in the respective work.

A distinction is made between the following groups of people in this manual:

- **Operating staff:** Have been demonstrably instructed in the operation and functioning of the machine. Are also responsible for daily and weekly maintenance and servicing work.
- **Specialists:** Specialists in the sense of the operating manual are persons who have been specially trained and instructed in the use of the machine and who have relevant knowledge in the areas of start-up and maintenance. In addition, specialists are familiar with the safety equipment and instructions and are responsible for the initial instruction of the operating staff.

1.3 Protective equipment

Personal protective equipment is used to protect the operating staff from impairments to safety and health at work.

Operating staff must wear personal protective equipment during the various operations on and with the machine, which is referred to separately in the individual sections of this operating manual.



Dust masks

Dust masks protect the respiratory tract from inhaling dust.



Safety shoes

Safety shoes protect the feet from heavy falling parts and prevent slipping on slippery surfaces.



Protective gloves

Protective gloves against mechanical abrasion protect the hands against injuries such as cuts, abrasions, etc.

Defective or worn protective gloves must be disposed of in an environmentally friendly manner.

1.4 General safety instructions

- Before the machine is put into service, please carefully read the operating manual provided as well as further separate instructions for additional devices or attachments and observe them in all aspects of your work. Moreover, the general safety and accident prevention regulations of the legislation must be taken into account.
The machine may be used, maintained and repaired only by persons who have been instructed by specialists.
- This machine is not intended to be used by persons (including children) with reduced physical, sensory or mental capabilities. This also applies to people without sufficient experience and skills.
- Children should be supervised to ensure they do not play with the machine.
- The operating manual should always be available at the machine's place of use and should therefore be stored with the machine.
- Please hand over these documents to the new owner/operator on sale or rental of the device. Have the hand-over confirmed!
- The warning, safety and instruction labels attached to the machine provide important information for safe operation. Renew labels that are no longer legible or present.
- Only wheels (wheel tyres) approved by Hako may be used.
- With Hako-AntiBac® machine variants, silver ions are contained in the plastic of the tank on the inside as well as in the flex wall.
- Spare parts must be original spare parts to guarantee safety.
- Operation of mobile phones is only permitted when the machine is stationary.
- It is not permitted to transport other people or heavy objects.
- Never use the machine without protection (overhead guard option) if there is a possibility of the driver being hit by falling objects.
- When leaving the machine, remove the key to secure the machine against unauthorised use.
- Do not operate the machine without properly mounted or installed safety devices. Do not bypass the function of the safety devices (e.g. the seat contact switch).
- Do not open covers and hoods during operation or when the machine is running.

1.5 Operating safety instructions

1.5.1 General

- The machine and the pre-sweep suction unit are not suitable for removing combustible or explosive liquids, dust or materials that are hazardous to health.
It is also prohibited to collect burning objects, e.g. glowing cigarettes.
The collection of wood dust, e.g. beech and oak dust, is also prohibited.
- The machine must not be used in potentially explosive atmospheres.
- Sturdy and slip-proof shoes must be worn when working with the machine.
- Only those surfaces approved by the contractor or its authorised representative for use of the machine may be driven on.
- Do not fill the tank with solvents or other aggressive chemicals.
- Only use detergents suitable for automatic machines (foam retarded) and observe the application, disposal and warning instructions provided by the detergent manufacturer.
- The machine is not suitable for collecting large quantities of water, e.g. in the event of flooding.
- Manipulating the switches and protective devices is forbidden.
- For reasons of safety, the driver's seat is equipped with a seat contact switch. The machine can only be started when the driver is sitting on the driver's seat. The function of the seat contact switch must not be bypassed.

1.5.2 Before putting into service

- Before initially starting up the machine, charge the used battery fully and appropriately with commissioning charge. Please observe the operating manual of the charger and the operating manual of the battery manufacturer. Hako assumes no liability for battery damage resulting from insufficient commissioning charge.
- Check proper condition and operating safety of the machine before every start-up! Do not use the machine as long as there are defects. Eliminate faults and defects immediately.
- Before starting work, the operating staff must familiarise themselves with all equipment, operating and actuating elements as well as with their function. It is too late to do this during operation!
- Before starting up, adjust the driver's seat so that the pedals can be operated safely and in a relaxed manner.
- Before starting up, adjust the height of the steering wheel to ensure a comfortable and relaxed hand and arm position.
- Before turning the machine off, always switch off all drives.

1.5.3 During operation

- When working with the machine, pay special attention to third persons, especially children.
- When driving over thresholds, all working units must be switched off beforehand.
- Excessive quantities of dust must be avoided when working with the pre-sweep suction unit!
- Switch on the warning device (BlueSpot, flashlight, acoustic warning reverse gear, etc.) (option) during all work and when transporting or moving the machine.
- When transporting the machine, raise the squeegee and the brush unit.
- Adapt the driving style and speed to the ambient conditions, the local conditions and the load condition of the machine.
- Three-wheeled vehicles have lower driving stability than four-wheeled vehicles and therefore tend to have a higher risk of tilting over. The following measures should be observed:
 - Avoid sudden steering movements at higher speeds or excessive speeds when turning.
 - Only turn the machine on level surfaces.
 - When driving uphill, downhill or across slopes, avoid sudden turns and drive slowly into the bend.

- Drive slowly on wet surfaces, particularly in bends, due to the risk of skidding.
- Do not press the steering wheel against the end stop for too long. The power steering could overheat and as a result the steering could become much more sluggish.
- Use the brake button in case of danger.
- Never leave the machine unattended until it has been stopped and secured against unintentional movement by removing the key.

Machine with standard drive:

- For cleaning purposes, the machine may only be used on a surface with a maximum slope of 6 % for two minutes.
- Transport on slopes of up to 10 % may only take place for one minute and with special caution.
- The machine must not be parked on an uphill or downhill gradient greater than 10 %!

Machine with X-AC drive:

- Cleaning may only be carried out on slopes of up to 15 % for a duration of up to three minutes.
- Transport on slopes of up to 18 % may only take place for a maximum duration of two minutes.
- The machine must not be parked on an uphill or downhill gradient greater than 15 %!

Dirt hopper (B400 RM/RH):

- Ensure there is sufficient ventilation when carrying out sweeping work in enclosed rooms.
- Never exceed the permissible total weight and the permissible axle loads. Check the filling level of the dirt hopper at regular intervals.
- Shaking the filter is only permitted with the dirt hopper inserted and closed.

Dirt hopper (B400 RH only):

- When raising and lowering the dirt hopper, there is a risk of crushing or shearing for nearby persons.
Ensure a sufficient safety distance.
When raising and lowering the dirt hopper, there must be no persons, animals or objects in the work area.

High-pressure cleaner (option)

- There is a risk of injury.
The jet of the high-pressure cleaner must not be directed at persons.
- Depressurise pressurised parts (hoses, etc.) when taking the machine out of service and before maintenance and repair work.
- Do not use high-pressure cleaners for cleaning electrical/electronic components or the machine.
- Only use suitable extension lines approved by the manufacturer. If an extension hose is used, the plug and coupling must be water-tight.
- Use only with the machine at standstill and the parking brake applied.
- Make sure that no unauthorised person is on or near the machine while working with the high-pressure cleaner or other cleaning tools.
- Use the high-pressure lance only when standing on a firm surface, e.g. not on ladders or from the driver's seat.
- The maximum operating pressure set by the manufacturer may not be increased.

1.5.4 After operation

- Turn off the machine and remove the key when leaving the machine to prevent unauthorised use.
- After use, park the machine in a dry, indoor location with the working units raised.

1.6 Maintenance instructions

- Daily and weekly maintenance work must be done in accordance with the maintenance plan by instructed operating staff. For all other maintenance work, please contact your nearest Hako service workshop.
- The maintenance work and maintenance intervals specified in the operating manual service booklet must be complied with.
- Suitable tools and protective clothing such as protective gloves and safety shoes must be used during cleaning, repair and maintenance work.
- Have the machine checked for safe condition by an expert in accordance with the accident prevention regulations at appropriate intervals (we recommend at least once yearly).
- Spare parts must at least comply with the technical requirements specified by the manufacturer. This is guaranteed by original spare parts.
- Turn the machine off, remove the key and disconnect the battery plug when cleaning and maintaining the machine and before replacing parts.
- Cleaning the machine with a water jet, high-pressure cleaner or steam jet is not permitted!
- Application of aggressive and corrosive detergents for cleaning the machine is not allowed.
- After cleaning, let the machine air dry, e.g. over the weekend. To do this, leave the tank cap open.
- Only put the machine into service when all the protective devices are attached and in protection position.
- Do not perform any welding, drilling, sawing or grinding work on parts of the frame. Have damaged parts replaced by a Hako service workshop.
- When transporting the machine, the machine must be shut down and properly lashed down.
- Detergents, oils and greases must be collected separately in suitable containers and disposed of in accordance with local regulations. Spilled substances must be cleaned up immediately.

Changing the battery (standard)

- When raising and lowering the battery trough with a crane, there is a risk of injury from falling and uncontrolled swinging parts.
The operator must be instructed by the owner in the operation of the crane and informed of the risks associated with its operation.
Only use the attachment points provided.
When changing the battery trough, use a suitable battery changing cross-beam (according to VDI 3616) and sufficiently load-bearing crane gear.
Do not hook in the chains at too shallow an angle, otherwise the tensile forces in the chains can increase to several times the weight of the battery and the chains may break.
Do not lower or place lifting gear and chains (according to VDI 3616) on the battery cells.
Never use damaged crane gear.
Lifting hooks should not cause damage to battery cells, connectors or connecting cables.
Keep a sufficient distance from the battery trough.
Attach the crane hook ensuring it is centred over the battery trough.
Carefully lift the battery trough and ensure that the battery trough does not tip over. Change the attachment point if necessary.
Wear safety shoes and protective gloves.

Changing the battery (battery changing system – option)

- Wear safety shoes when changing the battery.
- Risk of crushing at the roller supports on the vehicle and on the battery changing rack.
Do not touch the roller supports on the vehicle and on the battery changing rack while the battery is moving!
- Risk of crushing when lifting and lowering the battery changing rack.
Do not reach between the lift truck and the battery changing rack when lifting.
Do not touch the contact surfaces.
When lowering the battery changing rack, keep sufficient distance to the feet of the battery changing rack!
- Risk of crushing while the battery is moving.
Do not stay in the battery changing rack while the battery is moving!
- Change the battery only on level ground, never on sloping or uneven ground.

Dirt hopper (B400 RM/RH only):

- Shaking the filter is only permitted with the dirt hopper inserted and closed.
- Only tip out the hopper from a possible low height in order to prevent the formation of dust.
- The dirt hopper must be cleaned at regular intervals to prevent the accumulation of bacteria.

Dirt hopper (B400 RH only):

- For high dump of the dirt hopper, the machine must be parked on a level and solid surface.
- The dirt hopper may be raised only in the direct vicinity of the container.
- When the dirt hopper is raised, only drive at creep speed. Avoid abrupt steering movements or braking.

Waste water treatment (option)

- To clean the filter system of the waste water treatment, turn off the machine beforehand and remove the key switch.

High-pressure cleaner (option)

- Depressurise pressurised parts (hoses, etc.) when taking the machine out of service and before maintenance and repair work.
- Do not use high-pressure cleaners for cleaning electrical/electronic components or the machine.
- In winter and if there is a risk of frost, drain the water completely from the high-pressure cleaner.

1.7 Information about special risks

1.7.1 Electrical system

- Work on the electrical system may be done only in accordance with electrical engineering standards by a specialist trained for this work.
- Before carrying out any work or in the event of faults in the electrical system, the machine must always be turned off first, the battery plug must be disconnected and only then should work or fault rectification commence.
- Regularly inspect/check the electrical system of the machine. Defects such as loose connections, loose nuts of electrified bolts, electrical components or damaged cables must be eliminated immediately.
- Only use original fuses with the specified current. If stronger fuses are used, the electrical system can be destroyed and there can be fires.

1.7.2 Batteries

- Only instructed operating staff must handle and change batteries.
- Observe the operating manuals and safety instructions provided by the battery manufacturer.
- Never connect or disconnect batteries when the machine is turned on.
- Make sure the batteries are never fully discharged; recharge them as quickly as possible.
- Only batteries approved by Hako may be used at the intended position.
- **Danger!** Make sure that the insulation of the battery cables is not damaged. The battery cable should not rub against anything. If the insulation is defective, no longer use the machine and have the battery cables replaced by a Hako service workshop or the Hako customer service immediately.
- **Caution!** Always make sure that the batteries are clean and dry to avoid creeping currents and corrosion damage. Protect the batteries, in particular, against conductive contamination, e.g. metal dust.
- Risk of short circuits and spark formation! Never place tools or other electrically conductive objects on the battery!
- Do not remove insulating caps and covers, if necessary re-install them after carrying out work on the battery cables.



- Caution! Explosive gases can develop when charging the batteries. Avoid smoking, fire or naked light in the vicinity of batteries. Ensure sufficient ventilation when charging the batteries. Leave the driver's seat folded down. Only connect and disconnect the battery plug when the charger and the machine are turned off! Do not place the battery plug on the battery during charging! Never place tools or other electrically conductive objects on the battery!
- For further safety instructions, see Hako supplementary sheet 88-60-2556 – information for drive batteries.
- Only refill distilled water.
- There is a risk of crushing and shearing when installing and removing the battery trough.

1.7.3 Hydraulic system (B400 RH only)

- Highly pressurised fluids (e.g. hydraulic oil) can penetrate the skin and cause severe injuries. Therefore even with the smallest wounds, consult a doctor immediately since otherwise severe infections may arise.
- Work on hydraulic systems of the machine must only be carried out by specialists with special knowledge and experience in hydraulics.
- Regularly check all hoses, lines and screw connections for leaks and external visible damage. Immediately rectify damage and leaks. Oil squirting out can cause injuries and fires. Observe the replacement intervals for hydraulic lines. Replace hydraulic hose lines every five years from the date of manufacture even if they do not appear to be damaged!

1.8 Environmental protection instructions and disposal

If the end of use of the machine or of its components is reached and this is handed over for scrapping, the components must be correctly disposed of. Further information about disposal is available through the competent local authorities and the authorised Hako dealers.

	Do not dispose of products with this symbol in domestic waste. Disposal takes place through local collecting points or the manufacturer.
	Recycle used materials with this symbol according to their labelling and do not dispose of them in domestic waste.

- Observe the applicable laws and local regulations when disposing of dirt, waste water and detergents, also see the German Water Resources Law (WHG).
- Used batteries with the recycling symbol contain reusable commodities. In accordance with the symbol showing the crossed-out wheeled bin, these batteries must not be disposed of in domestic waste. Return and recycling have to be arranged with the authorised Hako dealer as required in § 6 and § 8 of the German battery law (BattG)!
- Observe the local regulations when disposing of the AntiBac® tanks, e.g. take the AntiBac® tanks to a suitable disposal site or incineration plant.
- Observe the local regulations when disposing of old oil, lubricants and filters.

1.9 Labels on the machine

The following safety and instruction labels are affixed to the machine in a clearly visible and legible manner. Renew missing or illegible labels immediately!

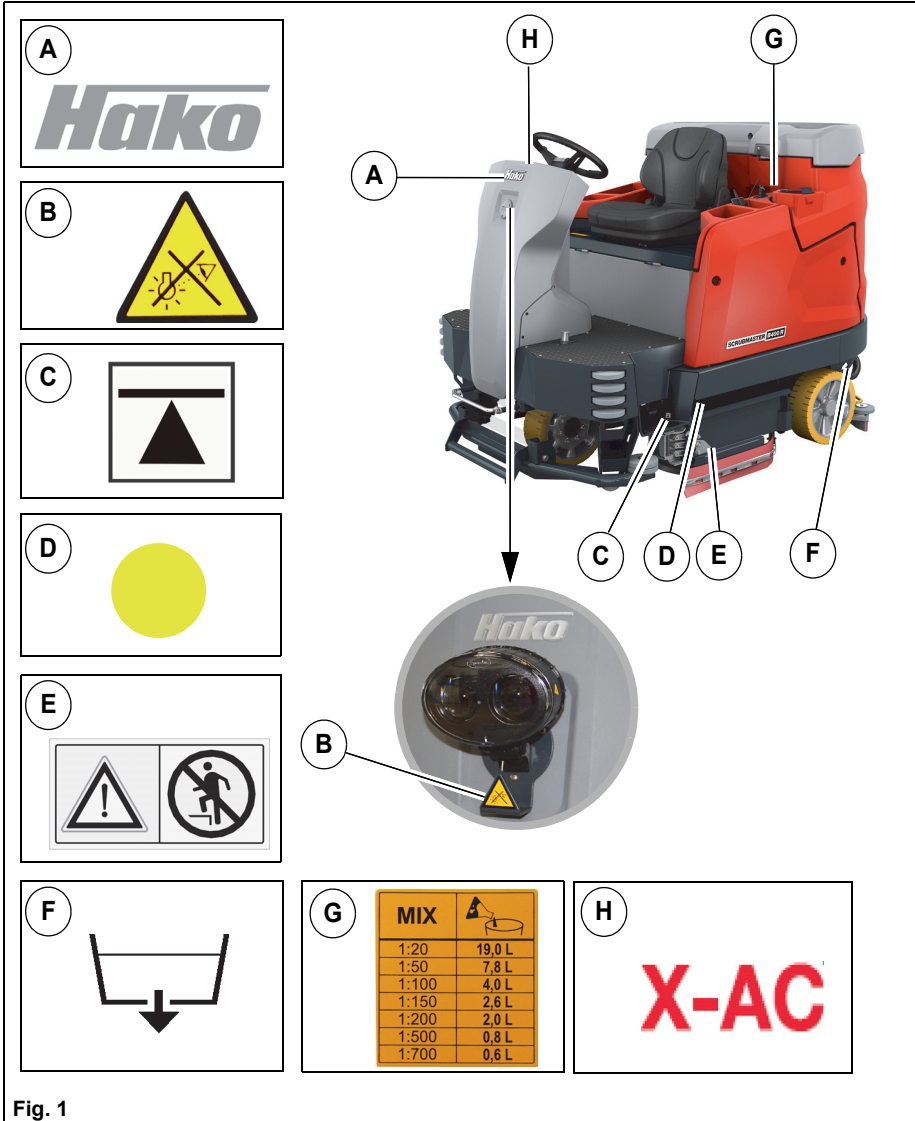

Fig. 1

Label: Company logo Fig. 1-A / Fig. 2-A

The Hako company logo is located at the front on the cover (B400 R) or on the hood (B400 RM/RH) and at the rear on the cap of the flex wall tank.

Label: Avoid looking directly at the light! Fig. 1-B

The label is located on the BlueSpot (option).

Label: Jacking points for lifting platform / vehicle jack Fig. 1-C / Fig. 2-C

The labels are located at the front of the steps and behind the rear wheels on the frame.

Label: Maintenance parts (yellow dot) Fig. 1-D

The yellow dot is located above the fresh water filter on the plate.

Label: Keep off! Fig. 1-E

The label is located on the side wipers.

Label: Drain fresh water Fig. 1-F

The label is located on the drain hose of the solution tank.

Label: Detergent dosing Fig. 1-G

The label is located on the left side of the machine on the filler cap for fresh water.

Label: X-AC drive Fig. 1-H

For machines with an X-AC drive, the label is located on the control panel (option).

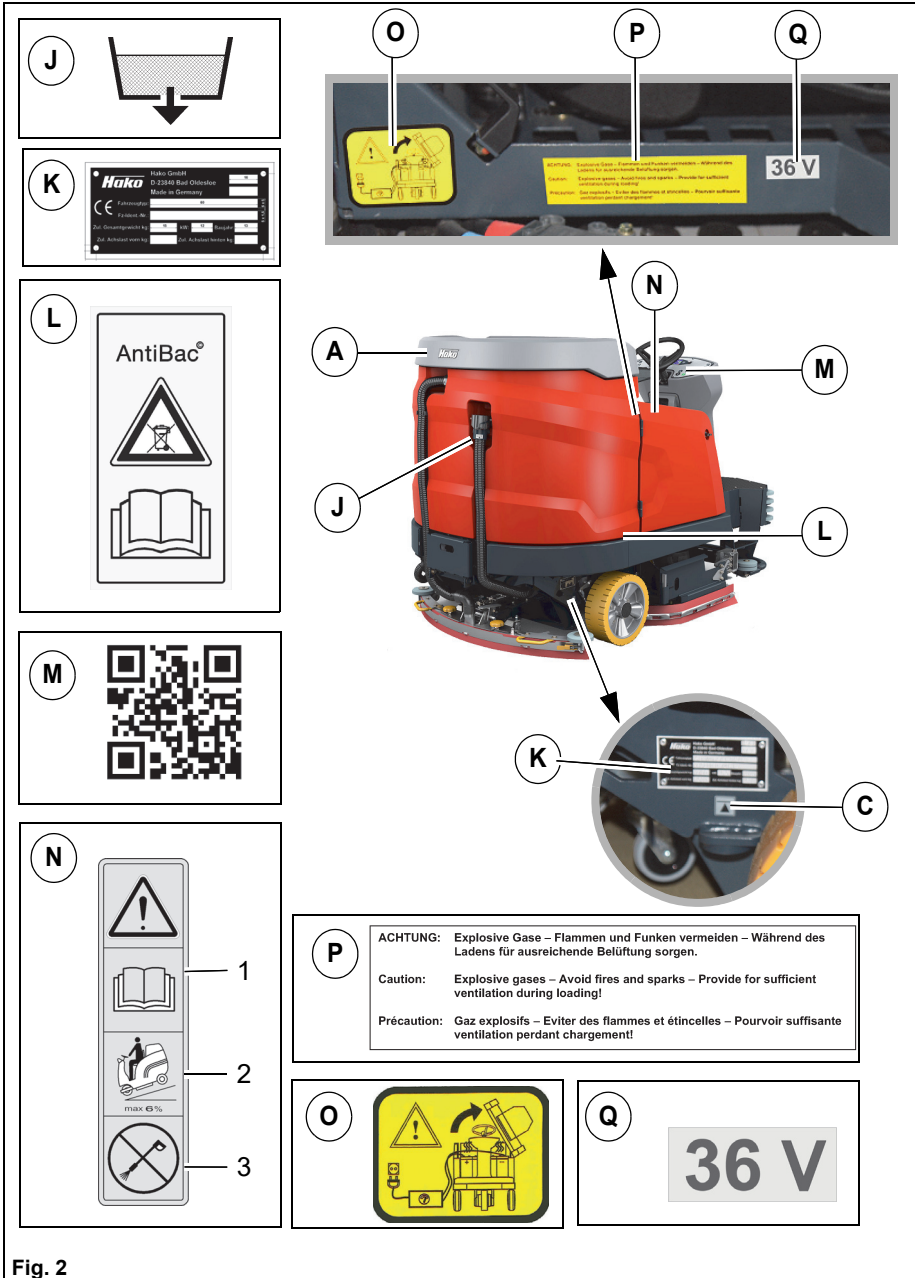

Fig. 2

Label: Drain waste water Fig. 2-J

The label is located on the drain hose of the waste water tank.

Label: Type plate Fig. 2-K

The type plate is located behind the right rear wheel.

Printing: Do not dispose of AntiBac® tanks in domestic waste – observe the information stipulated in the operating manual! Fig. 2-L

The printing is located on the front of the AntiBac® tank (option).

Label: QR code Fig. 2-M

The label is located on the control panel.

Label:

- **Read and observe the operating manual Fig. 2-N1**
- **Maximum permissible slope 6 % when cleaning Fig. 2-N2**
- **Never clean the machine with a high-pressure cleaner Fig. 2-N3**

The label is located on the right side next to the driver's seat.

Label: Leave seat console open during the charging procedure! Fig. 2-O

The label is located on the right side of the seat console underneath the armrest.

Label: Explosive gases Fig. 2-P

The label is located on the right side of the seat console underneath the driver's seat.

Label: 36 V Fig. 2-Q

The label is located on the right side of the seat console underneath the driver's seat.

2 Use

2.1 Overviews

The description in chapter 2 contains information on the function and handling of the individual controls on the machine.

2.1.1 Front view (B400 R)

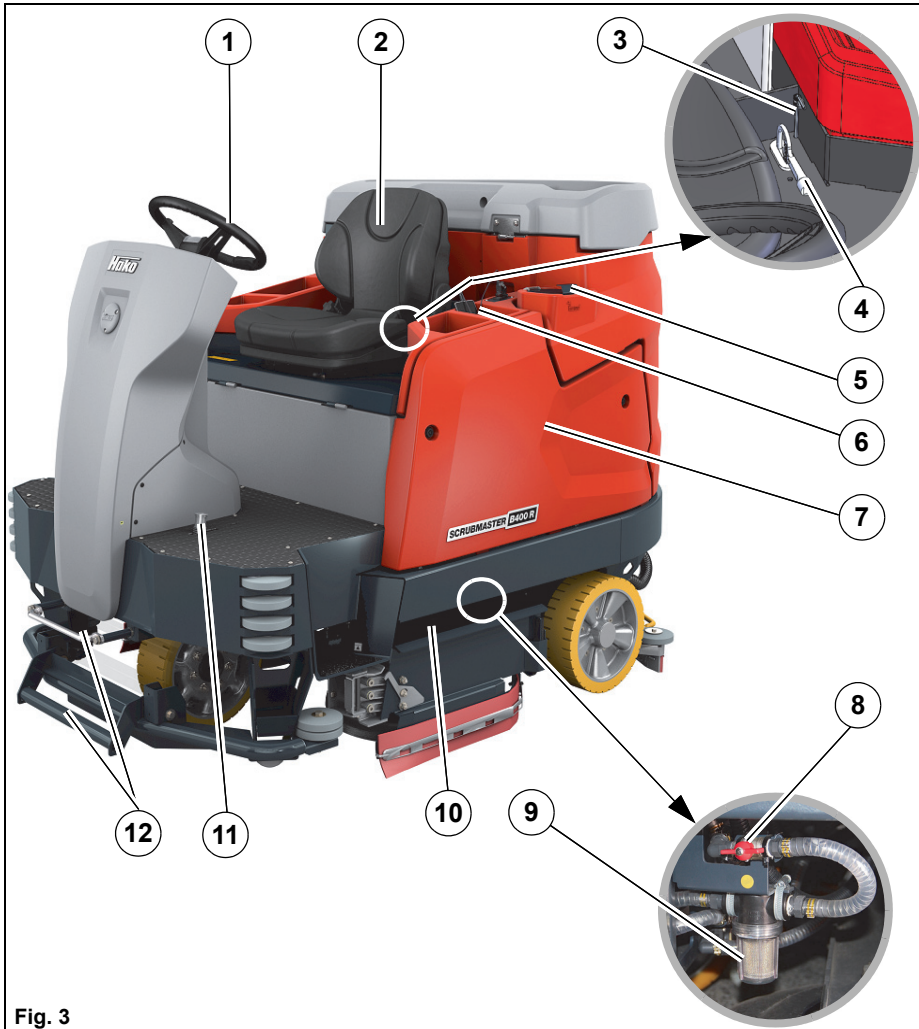

Fig. 3

Item	Designation
1	Steering wheel
2	Driver's seat
3	Key for rear steering column cover
4	Key for side panelling/side door
5	Fresh water filling opening
6	Drinks holder, storage compartment and socket for USB connection
7	Side panelling
8	Ball cock
9	Fresh water filter
10	Rotating brush unit
11	Brake button
12	Quick-Connect for light refuse collector, broom strip, mop strip (option)

2.1.2 Front view (B400 RM)

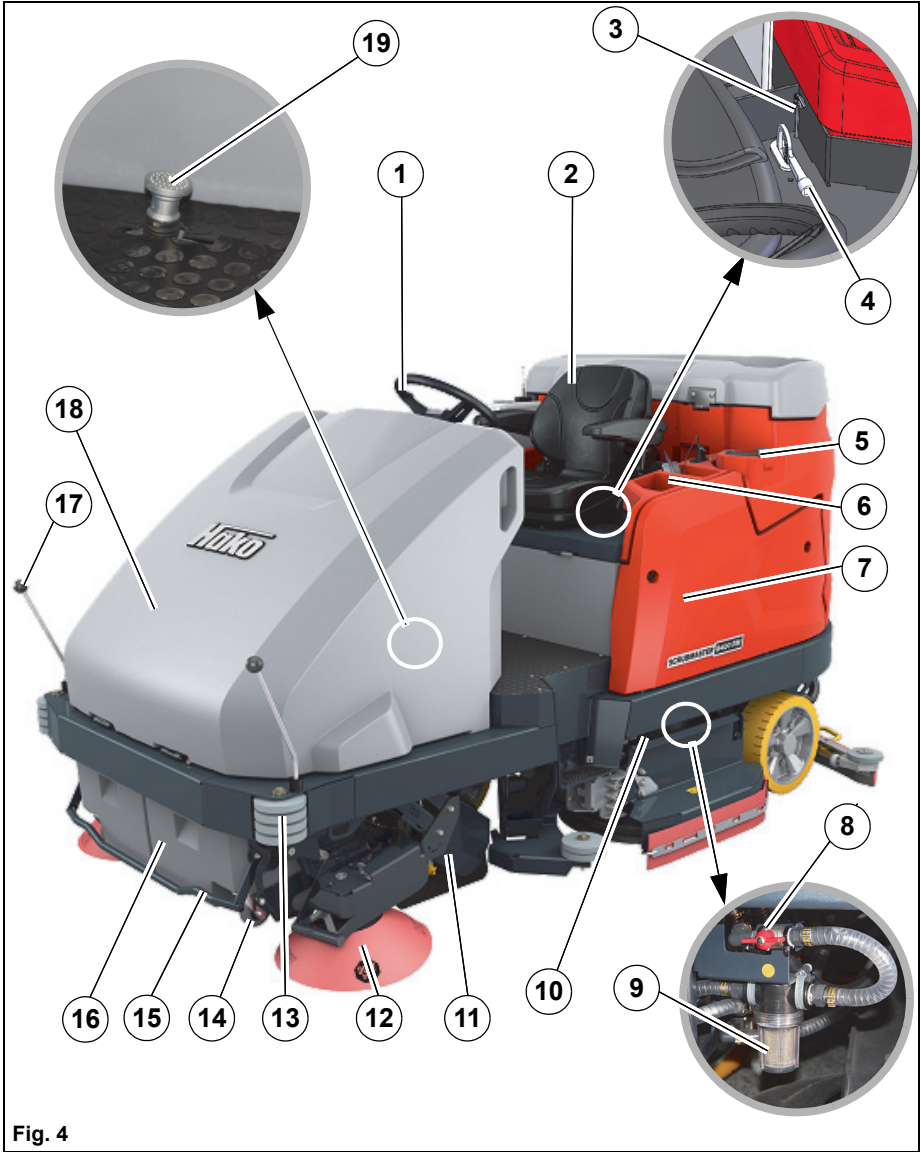

Fig. 4

Item	Designation
1	Steering wheel
2	Driver's seat
3	Key for rear steering column cover
4	Key for side panelling / side door / pre-sweep suction unit hood
5	Fresh water filling opening
6	Drinks holder, storage compartment and socket for USB connection
7	Side panelling
8	Ball cock
9	Fresh water filter
10	Rotating brush unit
11	Pre-sweep suction unit
12	Side broom with optional Dust Stop
13	Start rollers
14	Drive-up aid for ramps
15	Bracket for dirt hopper locking device
16	Dirt hopper
17	Dip stick
18	Pre-sweep suction unit hood
19	Brake button

2.1.3 Front view (B400 RH)



Fig. 5

Item	Designation
1	Steering wheel
2	BlueSpot (option)
3	Driver's seat
4	Flashlight (option)
5	Key for rear steering column cover
6	Key for side panelling / side door / pre-sweep suction unit hood
7	Drinks holder, storage compartment and socket for USB connection
8	Fresh water filling opening
9	Side panelling
10	Ball cock
11	Fresh water filter
12	Brake button
13	Rotating brush unit
14	Pre-sweep suction unit
15	Side broom with optional Dust Stop
16	Working light (option) / StVZO lighting (option)
17	Start rollers
18	Drive-up aid for ramps
19	High dump dirt hopper
20	Dip stick
21	Coarse material flap
22	Pre-sweep suction unit hood
23	Overhead guard (option)

2.1.4 Rear view

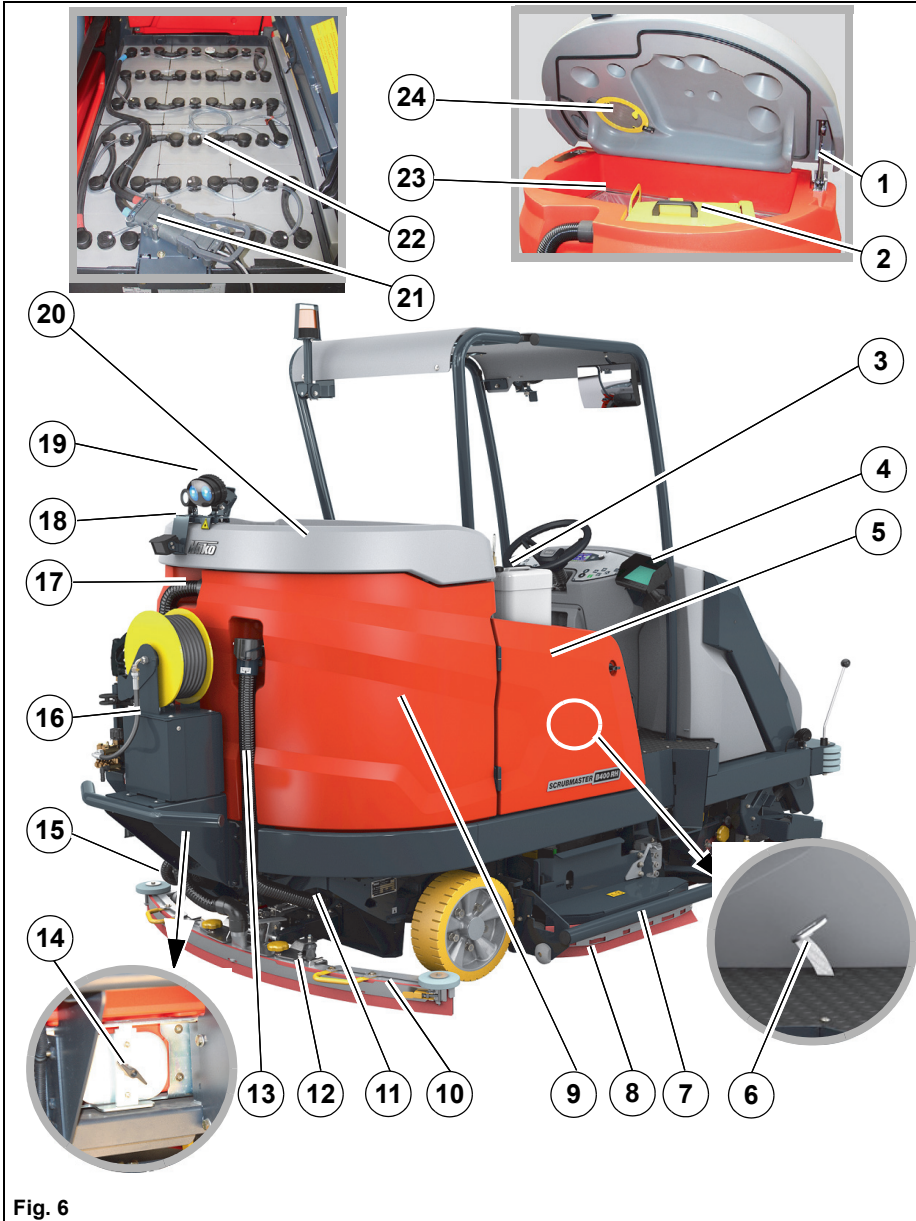

Fig. 6

Item	Designation
1	Cap support with locking device
2	Coarse dirt filter with filter tube
3	On-board dosing system (option)
4	Reversing camera monitor (option)
5	Battery trough side door
6	Accelerator pedal
7	Side collision protection (option)
8	Side wiper
9	Flex wall tank
10	Squeegee
11	Waste water tank maintenance opening
12	Squeegee water connection
13	Drain hose waste water
14	Folding step with solution tank maintenance opening behind it
15	Fresh water drain hose
16	Water treatment / high-pressure cleaner (option)
17	Suction hose
18	Working light, reversing camera with monitor (option)
19	BlueSpot (option)
20	Flex wall tank cap
21	Battery plug
22	Battery
23	Waste water tank
24	Intake sieve

2.1.5 Control panel

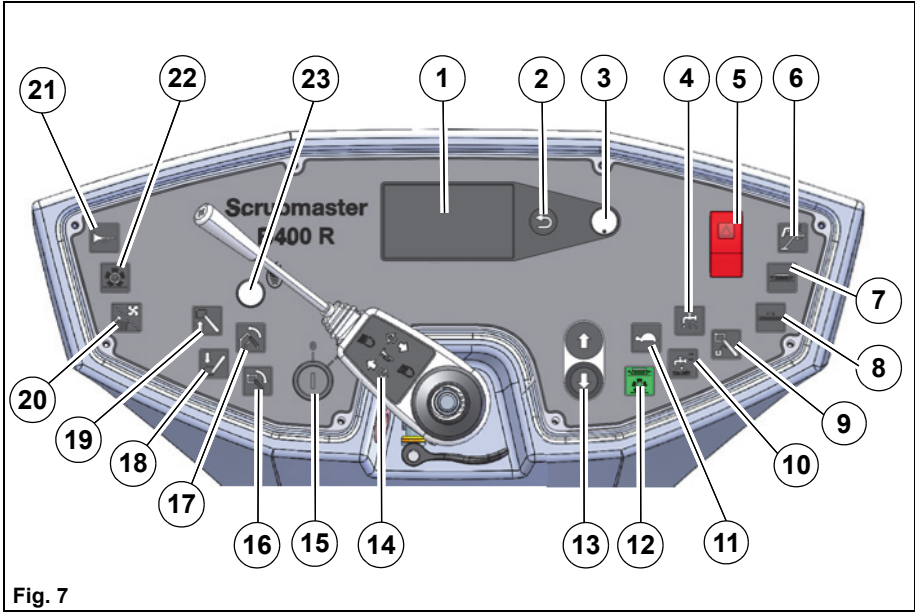

Fig. 7

Item	Designation
1	Multifunction display
2	Return button
3	Turn-push knob
4	Button <i>Fresh water supply</i>
5	Switch <i>Hazard warning system (option)</i>
6	Button <i>Tool operation (option)</i>
7	Button <i>Brush unit</i>
8	Button <i>Squeegee</i>
9	Button <i>High dump unlocking device (B400 RH only)</i>
10	Button <i>Boost function</i>
11	Button <i>Speed reduction forwards gear</i>
12	Button <i>Clean On</i>

13	Button <i>Driving direction selection</i>
14	Steering column switch (option)
15	Key switch
16	Button <i>Swivel back dirt hopper</i> (B400 RH only)
17	Button <i>Empty dirt hopper</i> (B400 RH only)
18	Button <i>Lower dirt hopper</i> (B400 RH only)
19	Button <i>Raise dirt hopper</i> (B400 RH only)
20	Button <i>Suction fan / Filter cleaning</i> (B400 RM/RH only)
21	Button <i>Signal horn</i>
22	Button <i>Pre-sweep suction unit</i> (B400 RM/RH only)
23	I-Button Reader (option)

2.2 Controls and display elements

2.2.1 Control panel

The individual functions of the buttons on the control panel are described below. The respective activated functions are visible as corresponding symbols on the multifunction display.

Fresh water supply button Fig. 7-4



The fresh water supply is switched on and off with this button.

- Press the button: Fresh water supply ON
- Press the button again: Fresh water supply OFF

Hazard warning system switch (option) Fig. 7-5



The hazard warning system is switched on and off with the switch.

- Press the switch at the top: Hazard warning system ON
- Press switch at the bottom: Hazard warning system OFF

Tool operation button (option) Fig. 7-6



The following tools can be switched on and off using this button when the driver is not on the seat:

- Spray nozzle
- Manual suction or spray suction tool

If the machine does not have a particular tool, it is excluded from the switching order.

- Press the button: Spray nozzle ON
- Press the button twice: Manual suction and spray suction tool ON
- Press the button again: Tool operation OFF

Brush unit button Fig. 7-7



The scrubbing cleaning program is started and stopped with this button. The brush unit is lowered or raised.

- Press the button: The brush unit is lowered. When actuating the accelerator pedal, the brush drives and the water supply are switched on.
- Press the button again: The brush drives and the water supply are switched off. The brush unit is raised.



Note

If the accelerator pedal is no longer actuated, the brush drives and the water supply are switched off.

Squeegee button Fig. 7-8



The squeegee is lowered and raised and the suction turbines switched on and off with this button.

- Press the button: The squeegee is lowered and the suction turbines are switched on.
- Press the button again: After approx. 15 seconds of after-run time, the squeegee is raised and the suction turbines are switched off.

High dump unlocking device button (B400 RH only) Fig. 7-9



High dump is selected with this button.

- Press the button: High dump unlocked
- Release the button: High dump locked



Note

This button must be pressed and held simultaneously with one of the following buttons, otherwise the dirt hopper cannot be moved.

- Button *Raise dirt hopper* Fig. 7-19
- Button *Empty dirt hopper* Fig. 7-17
- Button *Swivel back dirt hopper* Fig. 7-16
- Button *Lower dirt hopper* Fig. 7-18

Boost function button Fig. 7-10



In order to remove heavy contamination, the boost function can be used to boost the scrubbing-vacuuming cleaning programs (*Clean On* button Fig. 7-12) and scrubbing (button Fig. 7-7).

- Press and hold the button: the highest level of fresh water dosing and the increased brush pressure are activated simultaneously.
- Release the button: the machine switches back to the operating mode it was in before the boost function.

Speed reduction forwards gear button Fig. 7-11



The maximum speed when driving forwards is reduced by approx. 50 % with this button.

- Press the button: Speed reduction ON
- Press the button again: Speed reduction OFF

Clean On button Fig. 7-12



Note

The squeegee is automatically raised when reversing. The suction turbines remain switched on.

The scrubbing-vacuuming cleaning program is started and stopped with this button. The brush drives and the suction turbines are switched on and off simultaneously. In the B400 RM/RH variants, the pre-sweep suction unit is also switched on and off.

- Press the button: The brush unit and the squeegee are lowered, the suction turbines are switched on, the sweeping units (B400 RM/RH) are lowered and switched on. The brush drives and the water supply are switched on when the accelerator pedal is actuated.
- Press the button again: The brush units are raised. The brush drives, the water supply and the pre-sweep suction unit (B400 RM/RH) are switched off. The squeegee and the suction turbines continue to run for approx. 15 seconds to absorb residual water. The squeegee is then raised and the suction turbines are switched off.

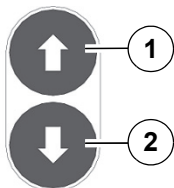
Driving direction selection button Fig. 7-13

The driving direction is selected with this button. When starting the machine, the driving direction is in neutral. The driving direction can be changed while driving.

- Press the button (1): Forwards gear
- Press the button (2): Reverse gear

**Note**

A warning signal is output when in reverse gear. The maximum speed when reversing is half of the maximum speed when driving forwards.

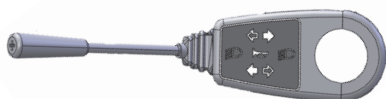
Steering column switch Fig. 7-14 (option)

The lighting system and the turn indicators are switched on and off with this button. More information on the individual functions, see section 6.11 *StVZO* on page 164.

Key switch Fig. 7-15



The electrical system is switched on or off with the key switch.

- Position 0: The electrical system is switched off. The key can be pulled out.
- Position 1: The electrical system is switched on.
 - The software version is displayed for approx. 1 second on the multi-function display, followed by the last service code for approx. 3 seconds if necessary. The operating hours meter is then displayed.

Swivel back dirt hopper button (B400 RH only) Fig. 7-16



The dirt hoppers are swivelled back with this button after being emptied. To do this, the *High dump unlocking device* button **Fig. 7-9** must additionally be pressed.

- Press the button: Straighten the dirt hopper
- Release the button: Dirt hopper movement stops

Empty dirt hopper button (B400 RH only) Fig. 7-17



The dirt hopper is tilted and subsequently emptied with this button. The prerequisite is that the dirt hopper is raised by a minimum amount. To do this, the *High dump unlocking device* button **Fig. 7-9** must additionally be pressed.

- Press the button: Swivel/Empty the dirt hopper
- Release the button: Dirt hopper movement stops

Lower dirt hopper button (B400 RH only) Fig. 7-18

The dirt hopper is lowered with this button. Complete lowering is only possible when the dirt hopper is straight. To do this, the *High dump unlocking device* button **Fig. 7-9** must additionally be pressed.

- Press the button: Lower the dirt hopper
- Release the button: Dirt hopper movement stops

Raise dirt hopper button (B400 RH only) Fig. 7-19

The dirt hopper is raised with this button. To do this, the *High dump unlocking device* button **Fig. 7-9** must additionally be pressed.

- Press the button: Raise the dirt hopper
- Release the button: Dirt hopper movement stops

Suction fan / Filter cleaning button (B400 RM/RH only) Fig. 7-20



The suction fan and the agitating function are switched on and off with this button. The agitating function removes adhering dust from the filter system of the pre-sweep suction unit. The function depends on the condition of the pre-sweep suction unit:

1. The suction fan is already running, the machine has been switched on with the green *Clean On* button **Fig. 7-12** or the pre-sweep suction unit with the button **Fig. 7-22**.
 - Press the button: Suction fan OFF – agitating function is carried out
 - Press the button again: Suction fan ON
2. The suction fan is switched off.
 - Press the button: Suction fan ON
 - Press the button again: Suction fan OFF – agitating function is carried out



Note

The agitating function is performed automatically when the sweeping function and/or the suction fan is switched off. The agitating function is carried out for approx. 6 seconds.

If the button is pressed again before the agitating function is stopped, the agitating function is interrupted and the suction fan is switched on.

Signal horn button Fig. 7-21



The signal horn is switched on with this button.

- Press the button: Signal horn ON
- Release the button: Signal horn OFF

Pre-sweep suction unit button Fig. 7-22 (B400 RM/RH only)

The pre-sweep suction unit (sweeping roller, suction fan and side broom) is switched on and off with this button. The pre-sweep suction unit can be switched on and off at any time.

- Press the button: Pre-sweep suction unit ON
- Press the button again: Pre-sweep suction unit OFF – filter cleaning is carried out

I-Button Reader (option) Fig. 7-23

The I-Button Reader is used to activate the functions and for access authorisation.

A red illuminated LED or a warning sound after switching on the machine requests the activation of the operating data recording system via the I-Button.

- Press the I-Button for approx. 2 seconds against the I-Button Reader.
 - The red LED goes out. The machine is ready for operation.

2.3 Multifunction display

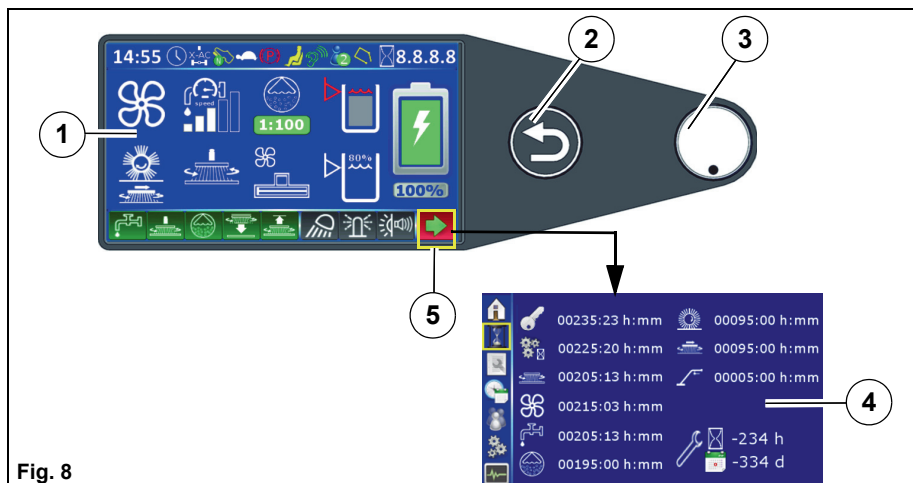

Fig. 8

- 1 Main menu
- 2 Return button
- 3 Turn-push knob
- 4 Sub-menu
- 5 Soft key *Menu selection*

The functions and indicators of the machine are set and displayed with the multifunction display. After the machine is switched on, the operating system and data are loaded and the start screen appears on the display. After several seconds the view changes, and the main menu **Fig. 8-1** appears. By selecting and confirming the soft key *Menu selection* **Fig. 8-5** you access the sub-menu **Fig. 8-4**.



Note

It is only possible to switch to the sub-menu if the cleaning functions are switched off!

2.3.1 Menu guidance

The menu is operated with the turn-push knob **Fig. 8-3**.

Menus and sub-menus are selected on the multifunction display and the individual menu item values are set or changed with the turn-push knob. The following basically applies:

- Turn to select a menu item. The selected menu item is displayed with a yellow border.
- Press to activate a menu item.

You can jump back to the previous menu using the return button **Fig. 8-2**.

2.3.2 Main menu

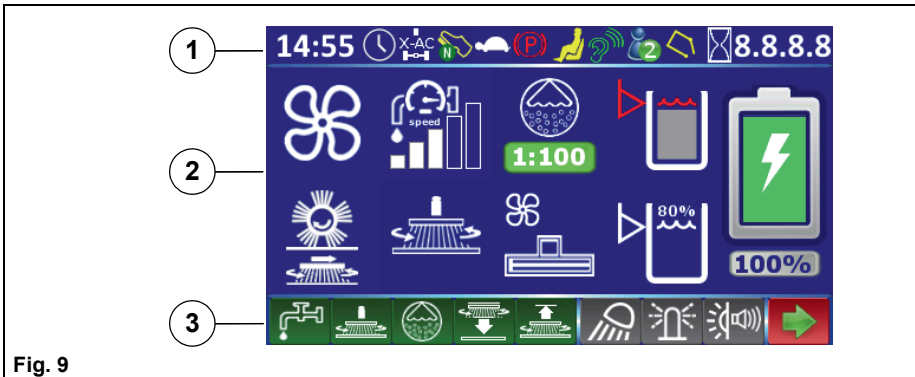







Fig. 9

The main menu is divided up into three levels.

- Status level **Fig. 9-1**
- Function level **Fig. 9-2**
- Action level **Fig. 9-3**













Symbols at status level







Symbol	Designation	Meaning
	Service alarm clock	Service alarm clock active.
	Service alarm clock	If the service alarm clock <i>has elapsed</i> , this symbol is <i>permanently visible</i> .
	X-AC drive	The symbol appears for two seconds if the X-AC drive is installed.
	Driving direction	The selected driving direction is displayed as a respective symbol. Example: Forwards gear
	Accelerator pedal in neutral position	This symbol appears when the accelerator pedal is in the neutral position.
	Speed reduction	The symbol is displayed when the machine is driving at reduced speed.
	Parking brake	The symbol is displayed when the parking brake is activated.
	Rear wheel parking brake is not operational	The symbol appears if the rear brake has been taken out of service mechanically. Driving is deactivated.
	Seat contact	The warning symbol lights up if the driver gets up from the driver's seat during operation. Main functions, e.g. scrubbing, vacuuming and driving, are no longer possible.
	User	The symbol indicates the currently set user profile.
	Silent operation	The symbol appears when the machine is working in reduced-noise operation. The symbol also appears at the <i>Squeegee</i> symbol.

	High dump	The symbol is displayed when the dirt hopper is raised or lowered.
	Tilt dirt hopper	The symbol is displayed when the dirt hopper is swivelled in the raised position.
	Operating hours meter	The operating hours in work mode are displayed. The operating hours for the individual units can be called up in the sub-menu.
	Service alarm clock	If the service alarm clock has expired after a certain number of operating hours, this symbol is permanently visible.
	Service indicator	The symbol appears if a service case occurred, but it had already been eliminated automatically or by operator intervention.
	Service indicator	The symbol appears if a service case occurs. An acoustic warning is also output and a four-digit service code appears on the right next to the symbol, see section 3.6 <i>Service information</i> on page 97.

Symbols at function level









All active units are displayed as symbols at function level.

Symbol	Designation	Meaning
	Pre-sweep suction unit and side broom	Pre-sweep suction unit and side broom active.
	Suction fan	Suction fan active.
	Agitating function	Agitating function of the filter is active. The function is performed automatically when the suction fan or pre-sweep suction unit is switched off.
	Speed-independent water dosing	The selected water dosing is displayed in the bar diagram.
	Speed-dependent water dosing	The selected water dosing is displayed in the bar diagram. Water quantity adaptive to driving speed.
	On-board dosing system	On-board dosing system active (option). The currently set mixing ratio is displayed.
	Rotating brush unit	Rotating brush unit active.
	Increased brush pressure, rotating brush	Rotating brush unit operates with increased brush pressure. At maximum brush pressure, two weights appear in the symbol.
	Squeegee	Squeegee and suction turbines active.
	Manual suction/ spray suction tool	Manual suction tool or spray suction tool active (options).
	Spray nozzle	Spray nozzle active (option).
	Spray nozzle	Spray nozzle active (option).

	Waste water treatment	Waste water treatment active (option).
	High-pressure cleaner	High-pressure cleaner active (option).
	Solution tank full	The current filling level of the solution tank is shown descending in steps of 20 %.
	Warning symbol – solution tank empty	The symbol appears when the filling level of the solution tank is only 5 litres. A warning sound is additionally output. Fill the solution tank immediately, see section 5.3.1 <i>Filling the solution tank</i> on page 121.
	Waste water tank almost full advance warning	The symbol appears when the waste water tank is already filled 90 %.
	Waste water tank full warning symbol	The symbol appears when the waste water tank is full. An acoustic warning is also output, and waste water collection is switched off. Empty the waste water tank immediately, see section 5.4.1 <i>Emptying the waste water tank</i> on page 125.
	Battery charging state indicator	The current charge level of the battery is displayed in steps of 10 %, see section 5.2.1 <i>Checking the charging state</i> on page 111.

Additional symbols

For more information there are additional symbols, which are explained in the following

Symbol	Designation	Meaning
	Warning symbol – red spanner	Faults in the functions are signalled by the red spanner. A 4-digit service code is also displayed at the same time.
	Warning symbol	If this symbol appears, the unit <ul style="list-style-type: none"> • is not installed or • not configured Example: Pre-sweep suction unit not installed.
	Symbol OFF	If the symbol appears, the function is switched off. Example: The water supply is switched off.
	Function symbol displayed in yellow	Interrupted functions are shown in yellow, e.g. if the accelerator pedal is in the neutral position. Example: Function interrupted by brush unit.
	Symbol displayed in grey	If a symbol appears in grey, the function cannot be started because the prerequisites for starting have not been fulfilled. Example: Switching to the sub-menu not possible.
	Open and closed locks (B400 RH only)	If a symbol with an open lock appears, a dirt hopper function can be performed because the <i>Dirt hopper unlocking device</i> button is pressed. Example: Lower dirt hopper function possible.
		If a symbol with a closed lock appears, a function of the dirt hopper is blocked or no button is pressed but the action window is still displayed. Example: Lower dirt hopper function locked.
	Function symbol with white arrow (B400 RH only)	If a symbol with a white arrow appears, a dirt hopper movement is carried out. Example: Lower the dirt hopper.

Action level

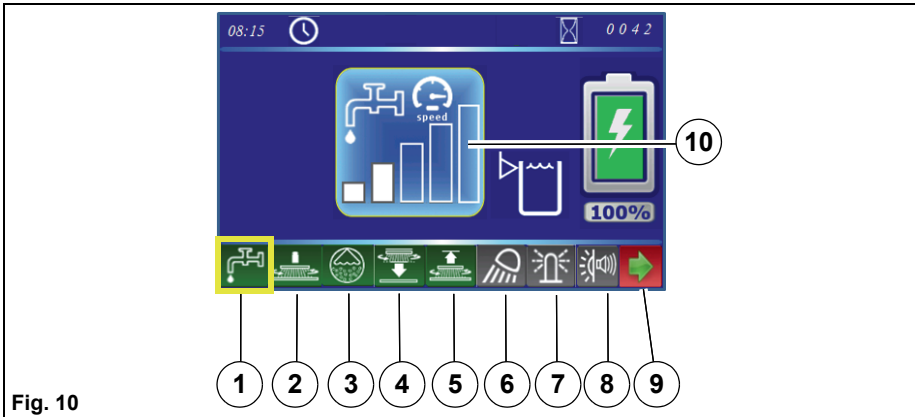



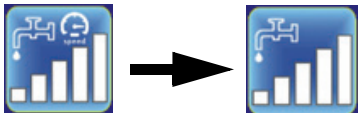





Fig. 10



- 1 Water dosing
- 2 Brush pressure increase
- 3 On-board dosing system (option)
- 4 Decoupling the rotating brushes
- 5 Coupling the rotating brushes
- 6 Working light (option)
- 7 Flashlight (option)
- 8 Warning device BlueSpot (option)
- 9 Soft key *Menu selection*
- 10 Action window

Settings can be made or actions performed in the action level using the soft keys **Fig. 10-1 to 8**.

The soft keys are selected by rotating the turn-push knob (soft key with yellow border) and confirmed by pressing. An action window **Fig. 10-10** opens, in which the settings can be carried out using the turn-push knob. The action windows close automatically after a few seconds or by pressing the return key.

The following actions are possible:



Soft key	Action window/ soft key	Setting
1 Water dosing	 	<p>Depending on the presetting, the action window appears for speed-dependent or speed-independent water dosing.</p> <ul style="list-style-type: none"> The water dosing has 5 settings. After reaching the highest speed-dependent water quantity, the speed dependence is deactivated by turning the turn-push knob clockwise. 
2 Brush pressure increase rotating brushes	 	<p>Brush pressure increase OFF</p> <p>1 weight = increased brush pressure</p> <p>2 weights = maximum brush pressure</p> <p>Green background = active</p>
3 On-board dosing system (option)		<p>Setting the mixing ratio, see section 3.4.2 <i>On-board dosing system (option)</i> on page 85.</p>
4 Decoupling the rotating brushes		<p>Decoupling the rotating brushes, see section 5.6.3 <i>Decoupling the rotating brushes/pads</i> on page 133.</p>
5 Coupling the rotating brushes		<p>Coupling the rotating brushes, see section 5.6.4 <i>Coupling the rotating brushes/pads</i> on page 134.</p>
6 Working light (option)		<p>Working light ON/OFF by means of direct selection using the soft key.</p> <p>If the working light is switched on, the colour of the soft key changes from white to green.</p> <ul style="list-style-type: none"> Rear working lights are on when reverse direction button Fig. 7-13 is activated.

<p>7 Flashlight (option)</p>		<p>Flashlight ON/OFF by means of direct selection using the soft key. If the flashlight is switched on, the colour of the soft key changes from white to green.</p>
<p>8 Warning device BlueSpot (option)</p>		<p>The following settings can be selected in the action window:</p> <ul style="list-style-type: none"> • BlueSpot ON/OFF • Acoustic warning reverse gear ON/OFF • BlueSpot and acoustic warning reverse gear ON/OFF <p>If the respective function is switched on, the colour changes from white to green. Example: BlueSpot OFF/Acoustic warning reverse gear ON</p>

High dump (B400 RH only)

The high dump symbol appears whenever at least one of the high dump buttons on the control panel **Fig. 7** is pressed. In contrast to the previous action windows, this symbol is just a status indicator.

 **Note**
The turn-push knob has no function in this action field!

Symbol	Setting
	<p>Raise/Lower high dump</p> <ul style="list-style-type: none"> • The function is enabled or locked – depending on the lock symbol • High dump not in motion
	<p>Tilt / straighten dirt hopper</p> <ul style="list-style-type: none"> • The function is enabled or locked – depending on the lock symbol • Dirt hopper not in motion

2.3.3 Sub-menu

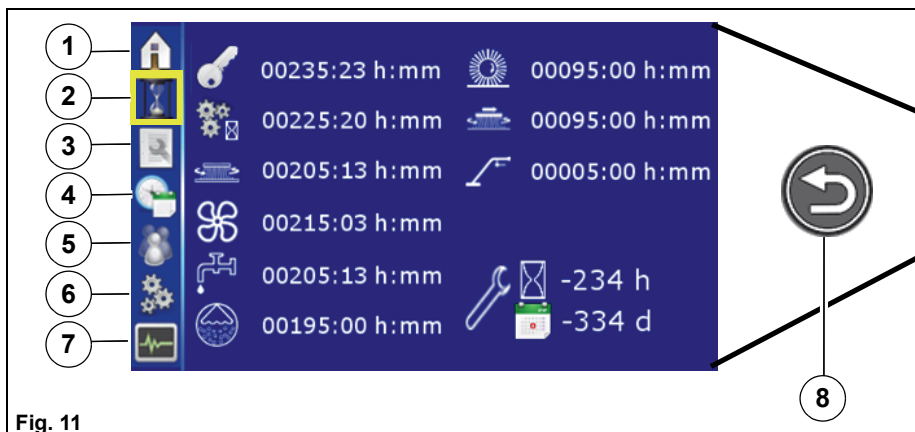

Fig. 11

- 1 Main menu
- 2 *Operating hours meter* menu
- 3 *Maintenance* menu
- 4 *Time/date* menu
- 5 *User settings* menu
- 6 Configuration menu
- 7 *Service information* menu
- 8 Turn-push knob

Configuration can be carried out, operating data read off and the clock/calendar set in the sub-menu. Some sub-menus require additional access rights. After calling up the sub-menu, the cursor automatically jumps to the operating hours menu.

To return to the main menu, press

- the soft key *Home* **Fig. 11-1** or
- the return button **Fig. 11-8** on the control panel.



The following sub-menus can be selected:

<p>Operating hours meter menu Fig. 11-2</p>	
<p>The screenshot shows a dark blue menu with a vertical sidebar on the left containing icons for home, settings, and other functions. The main area displays several rows of data: <ul style="list-style-type: none"> 00235:23 h:mm (sun icon) 00095:00 h:mm 00225:20 h:mm (truck icon) 00095:00 h:mm 00205:13 h:mm (wrench icon) 00005:00 h:mm 00215:03 h:mm 00205:13 h:mm (wrench icon) -234 h 00195:00 h:mm (wrench icon) -334 d </p>	<ul style="list-style-type: none"> • As well as the machine activation time and work mode, the operating hours of the individual units are displayed. • The remaining time until the next service is displayed in hours/days at the bottom right. If a service is required, the spanner appears in red.



Maintenance menu Fig. 11-3

<p>The screenshot shows a blue menu with a vertical sidebar on the left. The main area contains six large icons: <ul style="list-style-type: none"> An open book icon with a green 'START' button. A water tap icon with a red 'OFF' button. A squeegee icon with a red 'OFF' button. An information 'i' icon. A 'Fast-fill' icon with a green 'START' button. A 'next' icon with a green play button. </p>	<p>The <i>Maintenance</i> menu contains the following menu items:</p> <ul style="list-style-type: none"> • The <i>Maintenance instructions</i> sub-menu. • Activation/deactivation of speed-dependent water dosing. • Activation/deactivation of automatic squeegee cleaning. • The <i>information menu</i> contains information about software and hardware revisions. • To put the on-board dosing system into service, the detergent is conveyed to the rotating brush unit by activating the <i>Fast fill</i> menu. • Calling up the second page of the <i>Maintenance</i> menu.
<p>The screenshot shows a sub-menu with a blue sidebar on the left. The main area features a large image of a hand cleaning a circular filter. Above the image is a blue icon of an open book with a green 'START' button. At the bottom of the image, it says '03 / 15'.</p>	<p>The <i>Maintenance instructions</i> sub-menu opens, in which pictures for daily cleaning and maintenance are stored. Example: Cleaning the fresh water filter.</p> <p>When this menu is exited, a floppy disk appears. By selecting and pressing the <i>Floppy disk</i> symbol, you are confirming that you have carried out the maintenance.</p>
<p>Two square icons side-by-side. The left one shows a water tap with a green 'ON' button. The right one shows a water tap with a red 'OFF' button.</p>	<p>Speed-dependent water dosing ON/OFF</p>

Maintenance menu Fig. 11-3 continued

	<ul style="list-style-type: none"> • Automatic squeegee cleaning ON. • The time display in 5 second steps signals the time until shut-off. • Automatic squeegee cleaning OFF. <p>For further information, see section 5.11.1 <i>Cleaning the squeegee</i> on page 147.</p>
	<ul style="list-style-type: none"> • <i>Fast fill</i> menu ON. • The program continues to the end and finishes automatically. <p>For further information, see section 3.4.2 <i>On-board dosing system (option)</i> on page 85.</p>
	<p>The second page with further menu items opens.</p>

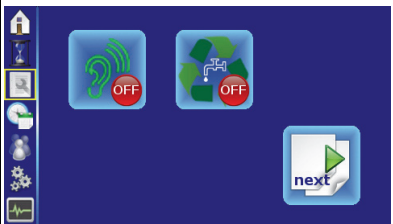
Maintenance menu Fig. 11-3 second page

	<p>The second page of the <i>Maintenance</i> menu contains the following menu items:</p> <ul style="list-style-type: none"> • Activating/Deactivating the silent function. • Activating/Deactivating water treatment (option). • Calling up the first page of the <i>Maintenance</i> menu.
	<ul style="list-style-type: none"> • Silent function ON/OFF <p>The suction turbine is switched to silent mode, which results in slightly reduced suction power.</p>
	<ul style="list-style-type: none"> • Water treatment (option) ON/OFF.

Time/date menu Fig. 11-4

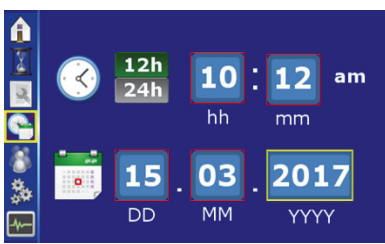

Time:

- Choice between 12 hour or 24 hour display.
- Set the clock in hours and minutes.

Date:
Set the date: day, month and year.

The set values are taken over when the menu is exited.

User settings menu Fig. 11-5

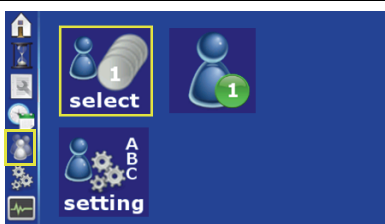

The *User settings* menu contains:

- *Selection of:*
 - *Specified settings (1-6)*
 - *User-specific settings (A-C)*
- *Specifying user-specific settings (A-C).*



Nine settings are available in the *Select* menu:

- The specified settings (1-6) contain predefined standard procedures.
- User-specific settings (A-C) contain user-defined function procedures and function restrictions.



The selected, active user profile is displayed as a number/letter with a green background.



Three programs (A, B, C) with user-specific settings can be stored in the *Setting* menu. The modification of user profiles requires additional access rights. This access authorisation is only intended for Hako service engineers.

Configuration menu Fig. 11-6

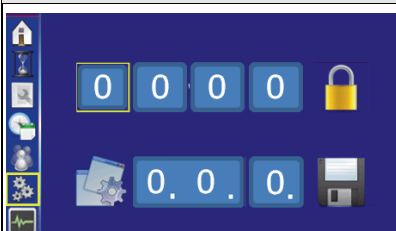

Making changes to the configuration menu requires additional access rights (4-digit numerical code). This access authorisation is only intended for Hako service engineers.

The following settings are made in the configuration menu:

- Activate/deactivate options.
- Setting of machine-specific parameters.

Service information menu Fig. 11-7

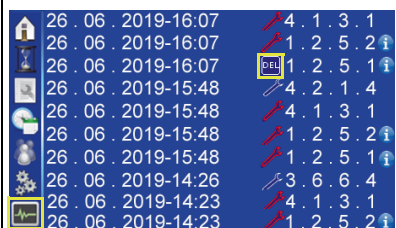

The last 10 items of service information are displayed in the service information menu. The operator can perform the following actions:

- Delete the last service information when the fault has been remedied.
- Obtaining detailed information.



Deletion of the last service information from the display:

Select the *Delete* symbol with the turn-push knob and press the turn-push knob for 3 seconds.

The Delete symbol is now no longer visible and the service code is no longer displayed after starting up the machine.



If the *Information* symbol appears next to the service code, detailed information can be requested.

Select the *Information* symbol with the turn-push knob and confirm. *Another window opens in which detailed information is displayed.*

Example: Brush motor overheating

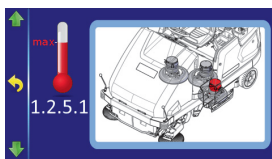

2.3.4 Controls at the machine



Fig. 12

- 1 Side door
- 2 Accelerator pedal
- 3 Waste water tank maintenance opening
- 4 Waste water tank drain hose
- 5 Maintenance opening solution tank

Side door Fig. 12-1

The battery is located behind the side door.

Accelerator pedal Fig. 12-2

The accelerator pedal is used to drive forwards or reverse and continuously adjust the speed at the same time.

If the accelerator pedal is not actuated, it automatically returns to the zero position and the machine stops.

Waste water tank maintenance opening Fig. 12-3

The cleaning opening is used for cleaning the waste water tank.

Drain hose for waste water Fig. 12-4

The waste water tank is drained using the drain hose.

Solution tank maintenance opening Fig. 12-5

The maintenance opening is used for cleaning the solution tank.

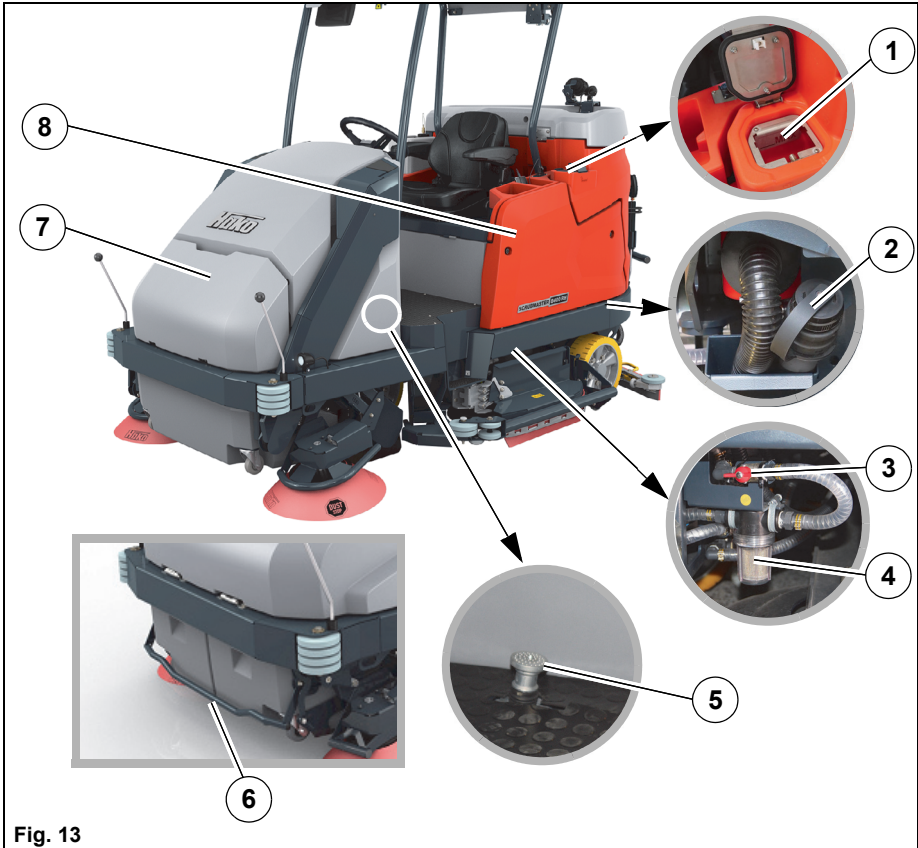

Fig. 13

- 1 Fresh water filling opening
- 2 Fresh water drain hose
- 3 Ball cock
- 4 Fresh water filter
- 5 Brake button
- 6 Bracket for dirt hopper locking device (B400 RM only)
- 7 Coarse material flap (B400 RH only)
- 8 Side panelling

Fresh water filling opening Fig. 13-1

The solution tank is filled via the filling opening.

**Note**

After opening, snap the cap into place again with a little hand pressure.

Optionally, the solution tank can be filled via the automatic filling unit, see section 5.3.1 *Filling the solution tank* on page 121.

Fresh water drain hose Fig. 13-2

The fresh water can be drained using the drain hose.

Ball cock Fig. 13-3

The ball cock is used to switch the water supply on and off manually in case the fresh water filter needs to be unscrewed.

Fresh water filter Fig. 13-4

When supplying water from the solution tank to the brush unit, the fresh water is cleaned by the filter insert.

Brake button Fig. 13-5

When the accelerator pedal is released (forwards or reverse) the machine comes to a stop due to the braking effect of the travel drive. If this braking effect is not sufficient, the brake button can additionally be used. After the machine has stopped, the parking brake is always activated automatically, irrespective of whether the brake button is pressed or not.

Bracket for dirt hopper locking device Fig. 13-6 (B400 RM only)

By pulling up the handle, the dirt hoppers are unlocked and swivelled down. After inserting the empty dirt hoppers, the bracket must be pressed down to raise and lock the dirt hoppers.

Coarse material flap Fig. 13-7 (B400 RH only)

The dirt hopper can be filled manually with large pieces of dirt (pieces of wood, film, etc.). This coarse dirt could block the sweeping roller. Before opening the coarse material flap, switch off the pre-sweep suction unit.

Opening the coarse material flap:

Reach into the central recessed grip on the front cover and open the coarse material flap in the driving direction.

Side panelling Fig. 13-8

The suction turbines and the electronics are located behind the side panelling. The side panelling can be easily removed using the provided wrench.

2.4 Functional description

Scrubmaster B400 R is a ride-on scrubber-drier for wet cleaning hard floor surfaces.

In cleaning mode, the cleaning solution is supplied from the solution tank to the rotating brushes in the brush unit. As the machine moves forward, waste water is picked up from the floor by the squeegee and, after passing through a two-stage filter system (coarse and fine dirt filter), it is conveyed into the waste water tank.

In the B400 RM and B400 RH variants, the Scrubmaster also has a pre-sweep suction unit. With this unit, the floor is cleaned beforehand with a sweeping roller and side brooms. The sweeping roller transports the dirt into the dirt hopper. The absorbed fine dust is sucked in by the suction fan and separated by the filter system. The air returned to the environment is always clean.

A seat contact ensures that the machine can only be operated when the operator is sitting on the seat.

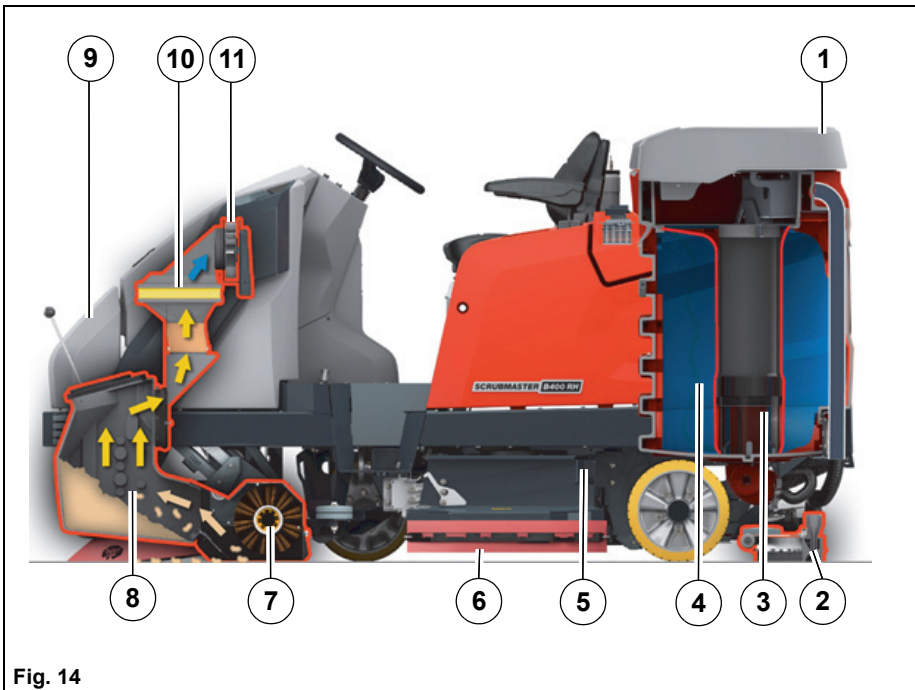

Fig. 14

- 1 Flex wall tank cap
- 2 Squeegee
- 3 Filter tube
- 4 Flex wall tank
- 5 Rotating brush unit
- 6 Side wiper
- 7 Sweeping roller (B400 RM/RH only)
- 8 Dirt hopper (B400 RM/RH only)
- 9 Pre-sweep suction unit hood (B400 RM/RH only)
- 10 Filter system (B400 RM/RH only)
- 11 Dust extraction system (B400 RM/RH only)

2.4.1 Solution tank

The solution tank of the flex wall tank **Fig. 14-4** is filled via the filling opening. The solution tank has a capacity of 400 litres when the waste water tank is empty. When full, the membrane lies against the filter tube **Fig. 14-3** of the waste water tank. The current filling level is shown on the multifunction display. If the filling level is less than 5 litres in the tank, the *Solution tank empty* symbol appears in the display panel and an acoustic warning indicates that topping up is required.

2.4.2 Rotating brush unit

The brushes in the rotating brush unit **Fig. 14-5** are driven by three electric motors. The brush unit is lowered with the *Brush unit* **Fig. 7-7** button. When actuating the accelerator pedal, the brush motors and the water supply are switched on. The floor is cleaned by the rotating brushes and the supply of cleaning solution. The brush pressure can be changed on the multifunction display.

There is an indicator on the right side of the machine showing the amount of brush wear.

The brushes in the rotating brush unit can be decoupled for maintenance purposes by pressing the soft key *Decouple rotating brushes* **Fig. 10-4** on the multifunction display, see section 5.6.3 *Decoupling the rotating brushes/pads* on page 133.

2.4.3 Squeegee

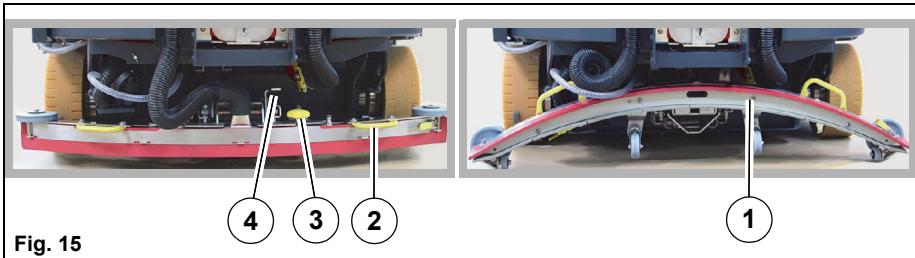

Fig. 15

- 1 Squeegee (folded up)
- 2 Handle
- 3 Star-shaped handle
- 4 Unlocking pedal

The movable, hinged squeegee **Fig. 15-1** is lowered and switched on with the *Squeegee* button **Fig. 7-8**. The squeegee withdraws the waste water from the floor using a sealing strip. The suction turbines vacuum the waste water from the floor. If the machine passes through narrow sections, e.g. doors, the squeegee can be removed by loosening the star-shaped handles **Fig. 15-3**. The squeegee can be folded up for maintenance purposes **Fig. 15-1**. To do this, pull the suction hose off the squeegee and press the pedal **Fig. 15-4** down. The squeegee is unlocked and folded up slightly. Use both handles **Fig. 15-2** to fold up the squeegee completely.

2.4.4 Waste water tank

The waste water vacuumed by the squeegee is conveyed via a suction hose **Fig. 6-16** into the waste water tank of the flex wall tank **Fig. 14-4**. When the waste water enters the waste water tank, it first flows through a coarse dirt filter and then through a filter tube **Fig. 14-3** with a fine dirt filter. A shut-off device inside the waste water tank automatically switches the suction turbine off when the maximum filling level is reached. In this case, a warning symbol illuminates on the multifunction display. An acoustic warning is output at the same time.

2.4.5 Side wiper

To the right and left of the rotating brush unit there are two side wipers **Fig. 14-6** which prevent spray water at the side in the working position and guide the cleaning solution to the centre of the vehicle, where it is easier to vacuum up.

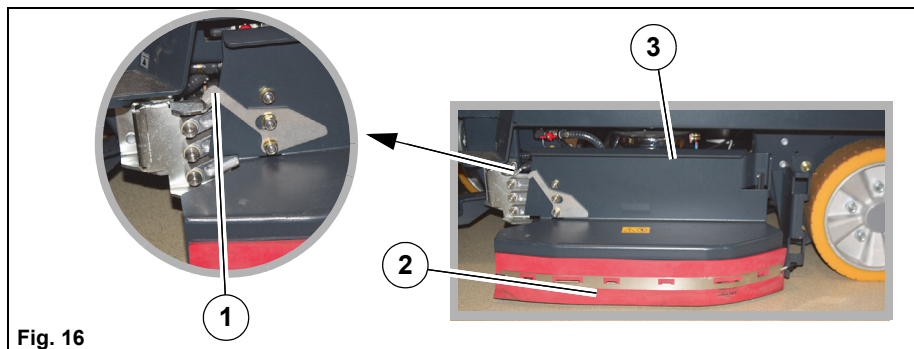

Fig. 16

- 1 Locking hook
- 2 Side wiper
- 3 Handle

The side wipers **Fig. 16-2** can be raised if necessary. To do this, raise the side wiper at the handle **Fig. 16-3** and hook the locking hook **Fig. 16-1** into the bracket above it.

For maintenance purposes, the side wipers can be swivelled to the side; to do this, first raise them and then swivel them away.

2.4.6 Suction turbines

The suction turbines are switched on and off automatically when cleaning and when the cleaning process is ended.

2.4.7 Travel drive

Standard

The travel drive is located at the front wheel and consists of an electric machine and a gearbox, and fulfils the functions of driving, braking and steering.

X-AC drive (option)

The X-AC drive is an electrical machine with a gearbox on the rear axle which acts as a drive and deceleration aid for the travel drive on the front axle.

Extra anti-slip tyre at the front (option)

The extra anti-slip tyre is a specially coated drive wheel. This coating reduces drive wheel spinning on steep slopes and on very slippery surfaces.

2.4.8 Brakes

The operator slows down the machine by releasing the accelerator pedal. A greater braking effect is achieved by pressing the brake button. When the machine comes to a standstill, the parking brake is automatically applied.

2.4.9 Batteries

The machine variants may be equipped with different battery types.

- Trough battery 36 V / 540 Ah PzS, 320 A wet (also for the optional battery changing system)
- Trough battery 36 V / 810 Ah PzS, 320 A wet



Note

For information on handling the optional battery changing system, see section 6.7 *Battery changing system* on page 157.

Battery management system (BMS)

All Scrubmaster B400 variants are equipped with a BMS. The BMS ensures that the battery system is monitored. The BMS is responsible for:

- determining the battery charging state during operation
- switching off the cleaning functions when the discharge limit has been reached to protect the battery against total discharge



Attention

When using other batteries which have been approved by Hako, the BMS must be reset to protect the battery against total discharge. The settings of the BMS must only be carried out by a Hako service workshop!

For more information, see section 5.2 *Battery* on page 111.

2.4.10 Sweeping roller (B400 RM/RH only)

The sweeping roller in the pre-sweep suction unit **Fig. 14-7** conveys the dirt into the dirt hopper. The height of the sweeping roller can be adjusted according to the state of wear using a yellow star-shaped handle.

2.4.11 Side broom (B400 RM/RH only)

Two side brooms **Fig. 4-12 / Fig. 5-15** are fitted at the front to brush up dirt in the area close to the wall and beyond the width of the squeegee. The side brooms brush the dirt directly into the path of the sweeping roller. The side brooms can be adjusted according to the state of wear using the yellow star-shaped handles. Optional Dust Stoppers can be fitted over the side brooms to reduce dust build-up.

2.4.12 Dirt hopper (B400 RM/RH only)

Depending on the variant, the dirt hopper **Fig. 14-8** must be emptied manually by the operator (B400 RM) or mechanically via high dump (B400 RH) directly into a container.

2.4.13 Filter system/Dust extraction system (B400 RM/RH only)

The filter system **Fig. 14-10** is located at the front above the dirt hopper. The suction fan transports the fine dust swirled up by the sweeping roller through the plate filter where it is separated. The fine dust settles on the outer surfaces of the filter blades.



Note

If there is a lot of dust, check the plate filter and clean it using the agitator.

Filter cleaning system

The dust deposited on the plate filter is removed when cleaning the filter and falls into the dirt hopper. The agitator is started automatically after the sweeping function or the suction fan has been switched off. If dust is generated while working with the machine, stop sweeping and activate filter cleaning via the **Fig. 7-20** button.

2.4.14 High-pressure cleaner (option)

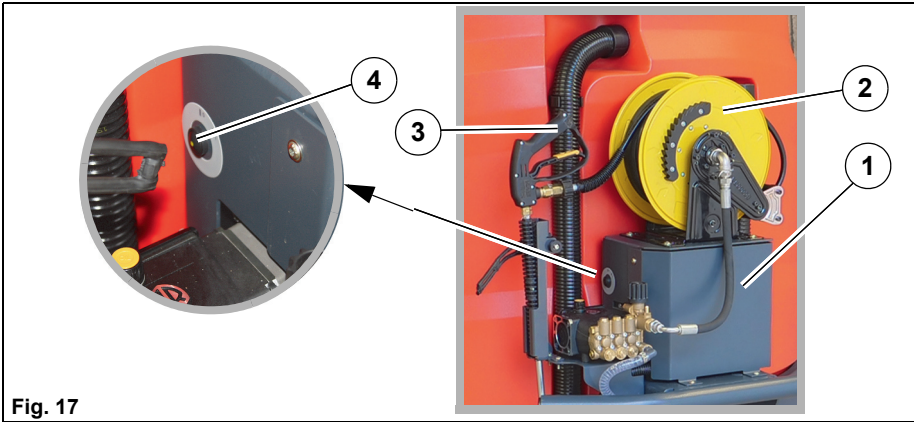

Fig. 17

- 1 High-pressure cleaner
- 2 Hose on reel
- 3 Spray lance
- 4 Button with integrated lamp

The high-pressure cleaner **Fig. 17-1** is located at the rear of the machine and is mounted on the chassis. The high-pressure cleaner is switched on and off via a separate button **Fig. 17-4** on the side of the high-pressure cleaner unit. If the high-pressure cleaner is switched on, a lamp in the button lights up and the symbol of the high-pressure cleaner appears in the function level of the multifunction display **Fig. 9**.

Information on the function and operation of the high-pressure cleaner, see section 6.12 *High-pressure cleaner* on page 166.

2.4.15 Steering column switch StVZO (option)

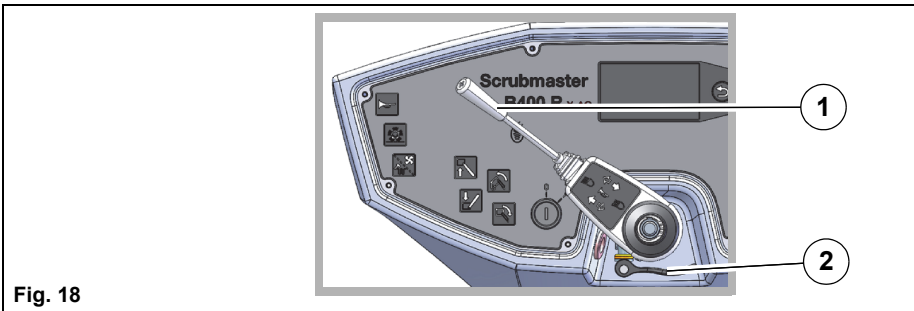

Fig. 18

- 1 Steering column switch
- 2 Quick release steering wheel height adjustment

The steering column switch is mounted on the steering column and is used to operate the turn indicators, the dipped headlights, the rear light and the horn. Information on the function and operation of the steering column switch, see section 6.11 StVZO on page 164.

2.4.16 Working light, reversing camera with monitor and flashlight (option)

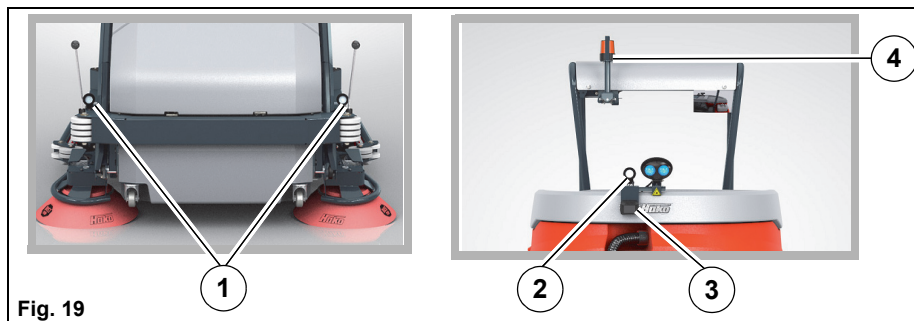

Fig. 19

- 1 Front working light
- 2 Rear working light
- 3 Reversing camera
- 4 Flashlight

The front working lights **Fig. 19-1** are mounted on the frame to the left and right of the pre-sweep suction unit hood and illuminate the front working area. The rear working light **Fig. 19-2** is mounted on the cap of the flex wall tank and illuminates the rear working area.

The working lights are switched on and off via the action level on the multi-function display **Fig. 9-3**.

A reversing camera **Fig. 19-3** may be mounted under the rear working light. The captured image is displayed on a monitor to the right of the control panel. The flashlight **Fig. 19-4** is mounted on the machine in such a way that it is clearly visible from all sides. If there is no overhead guard (option), the flashlight is located on the cap of the water tank. The flashlight is switched on and off via the multifunction display.

3 Operation



Danger

- The machine and the pre-sweep suction unit are not suitable for removing combustible or explosive liquids, dust or materials that are hazardous to health.
It is also prohibited to collect burning objects, e.g. glowing cigarettes.
The collection of wood dust, e.g. beech and oak dust, is also prohibited.
- The machine must not be used in potentially explosive atmospheres.



Warning

- Sturdy and slip-proof shoes must be worn when working with the machine.
- Only those surfaces approved by the contractor or its authorised representative for use of the machine may be driven on.
- Never use the machine without protection (overhead guard option) if there is a possibility of the driver being hit by falling objects.
- Do not fill the tank with solvents or other aggressive chemicals.
- Only use detergents suitable for automatic machines (foam retarded) and observe the application, disposal and warning instructions provided by the detergent manufacturer.
- The machine is not suitable for collecting large quantities of water, e.g. in the event of flooding.
- Manipulating the switches and protective devices is forbidden.
- For reasons of safety, the driver's seat is equipped with a seat contact switch. The machine can only be started when the driver is sitting on the driver's seat. The function of the seat contact switch must not be bypassed.



Attention

- Risk of the servo drive overheating.
Do not press the steering wheel against the end stop for too long. The power steering could overheat and as a result the steering could become much more sluggish.

3.1 Instruction

Instruction is required before the first start-up. The first-time instruction of the machine must be provided only by a specialist of your authorised Hako dealer.

3.2 Before putting into service



Warning

- Check proper condition and operating safety of the machine before every start-up! Do not use the machine as long as there are defects.
Eliminate faults and defects immediately.
- Before starting work, the operating staff must familiarise themselves with all equipment, operating and actuating elements as well as with their function. It is too late to do this during operation!
- Never use the machine without protection (overhead guard option) if there is a possibility of the driver being hit by falling objects.
- Before starting up, adjust the driver's seat so that the pedals can be operated safely and in a relaxed manner.



Attention

- Before initially starting up the machine, charge the used battery fully and appropriately with commissioning charge. Please observe the operating manual of the charger and the operating manual of the battery manufacturer. Hako assumes no liability for battery damage resulting from insufficient commissioning charge.

3.3 Check list: Before machine start-up

	Description	Section
1	Check the parking area for signs of leaks. Cables and tanks must not show any sign of leaks or damage.	
2	Check proper functioning of the working light, flashlight and warning device (option).	3.3.1
3	Check proper functioning of the lighting system and horn (option).	3.3.2
3	Adjust the driver's seat if necessary.	3.3.3
4	Adjust the steering wheel if necessary (option).	3.3.4
5	Adjust the side mirror (overhead guard option).	3.3.5
6	Check the detergent quantity in the canister (on-board dosing system option), change the canister and adjust the mixing ratio if necessary.	3.4.2
7	Empty the dirt hopper and clean it as required (B400 RM/RH only).	5.7
	Check the dirt hopper locking device (B400 RH only).	
8	Check the battery charge and recharge it as required.	5.2.2
9	If necessary, install the battery socket at the battery trough.	5.2.4
10	Check the locking device of the side panelling and side door.	
11	If necessary, install the rotating brushes.	5.6.4
12	If necessary, install the squeegee.	5.11.2
13	If necessary, install the sweeping roller.	5.8.4
14	Empty the waste water tank and clean it as required.	5.4.1
		5.4.2
15	Fill the solution tank and add detergent according to the manufacturer's specifications.	5.3.1

3.3.1 Checking the working light, flashlight and warning device (option)

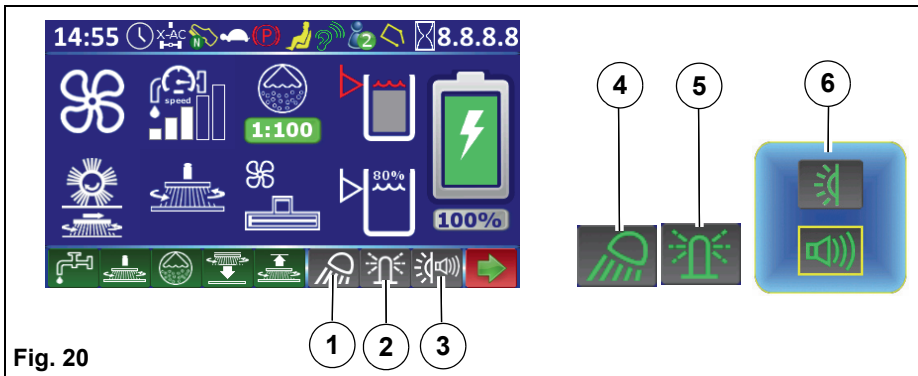

Fig. 20

- 1 Soft key *Working light OFF*
- 2 Soft key *Flashlight OFF*
- 3 Soft key *Warning device OFF*
- 4 Soft key *Working light ON*
- 5 Soft key *Flashlight ON*
- 6 Action window *BlueSpot ON/Acoustic warning reverse gear ON*

1. Turn the machine on with the key switch.
2. Check the working light, the flashlight and the warning device in the action level one after the other, see section *Action level* on page 54.
3. Turn the machine off with the key switch.



Note

If one of the lights or warning devices does not work, contact your Hako service workshop!

3.3.2 Checking the lighting system and horn (option)

1. Turn the machine on with the key switch.
2. Check the turn indicators, dipped headlights, rear lights (brake light, reversing light, etc.), headlight flasher, hazard warning system and horn one after the other, see section 6.11 StVZO on page 164.
3. Turn the machine off with the key switch.



Note

If one of the lights or the horn does not work, contact your Hako service workshop!

3.3.3 Driver's seat



Danger

- There is a risk of accidents if the driver's seat is adjusted while driving.
- Only adjust the seat if the machine is stationary.



Warning

- For reasons of safety, the driver's seat is equipped with a seat contact switch. The function of the seat contact switch must not be bypassed.

Adjust the driver's seat in such a way that all controls can be easily reached.

Adjusting the standard / comfort driver's seat (option)

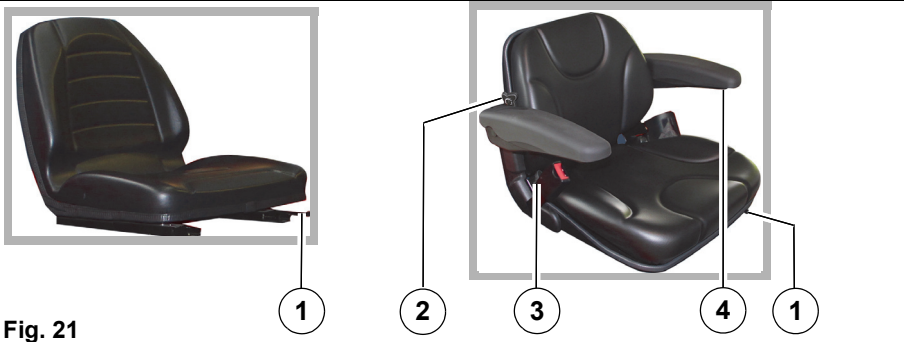

Fig. 21

- 1 Seat adjustment lever
- 2 Backrest handwheel (comfort only)
- 3 Seat suspension (comfort only)
- 4 Armrest wheel (comfort only)

Sit on the driver's seat and adjust as follows:

Adjusting in longitudinal direction (standard / comfort)

1. Push the lever **Fig. 21-1** outwards.
2. Move the seat forwards or backwards.
3. Release the lever **Fig. 21-1** and let the driver's seat engage.

Further adjustment options for comfort driver's seat (option):

Adjusting the tilt of the backrest

Adjust the tilt of the backrest by turning the handwheel **Fig. 21-2**.

Adjusting the seat suspension

The seat suspension can be continuously adjusted to the weight of the driver (50 - 120 kg) by turning the handwheel **Fig. 21-3**.

- Drivers who weigh less turn the handwheel **Fig. 21-3** to the left.
- Drivers who weigh more turn the handwheel to the right.

Adjusting the tilt of the armrests

Adjust the tilt of the armrests by turning the wheel **Fig. 21-4**.

The armrests can be folded up when not in use.

3.3.4 Steering wheel height adjustment (option)



Danger

- There is a risk of accidents if the steering wheel is adjusted while driving.
- Before starting up, adjust the height of the steering wheel to ensure a comfortable and relaxed hand and arm position.
- Only adjust the steering wheel if the machine is stationary.
- The steering wheel must be locked after adjustment.
- With the StVZO option, the position of the steering column switch must also be checked and adjusted if necessary.

Adjust the height of the steering wheel so that the hands and arms are in a comfortable and relaxed position.

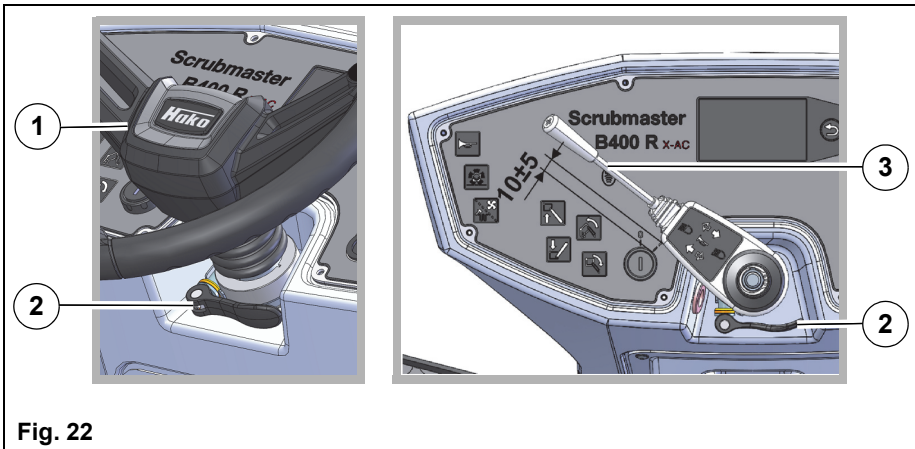

Fig. 22

- 1 Steering wheel
- 2 Quick release
- 3 Steering column switch position (StVZO option)

1. Loosen the quick release **Fig. 22-2** on the steering column to the rear.
2. Raise or lower the steering wheel to the desired height.
3. Hold the steering wheel in this position.
4. **Only with StVZO option:**
Move the steering column switch **Fig. 22-3** to the position shown.
5. Close the quick release again.
6. Make sure that the steering wheel can no longer be moved up and down, readjust the quick release if necessary.

3.3.5 Side mirror (option) adjustment

**Danger**

- Never adjust the side mirror while driving. Risk of accident!
- Only adjust the side mirror if the machine is stationary.

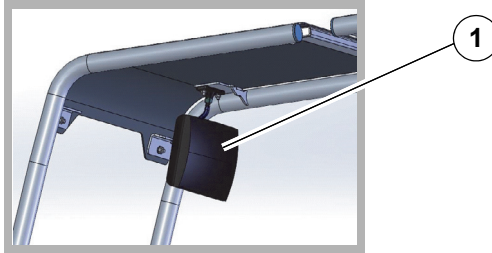

Fig. 23

Adjust the outside mirrors on the overhead guard **Fig. 23-1** so that a full view of the rear working area is provided.

3.4 Cleaning



Warning

- Three-wheeled vehicles have lower driving stability than four-wheeled vehicles and therefore tend to have a higher risk of tilting over. The following measures should be observed:
 - Avoid sudden steering movements at higher speeds or excessive speeds when turning.
 - Only turn the machine on level surfaces.
 - When driving uphill, downhill or across slopes, avoid sudden turns and drive slowly into the bend.
 - Drive slowly on wet surfaces, particularly in bends, due to the risk of skidding.
- Adapt the driving style and speed to the ambient conditions, the local conditions and the load condition of the machine.
- Never leave the machine unattended until it has been stopped and secured against unintentional movement by removing the key.
- When working with the machine, pay special attention to third persons, especially children.
- When driving over thresholds, all working units must be switched off beforehand.
- Excessive quantities of dust must be avoided when working with the pre-sweep suction unit!
- Switch on the warning device (BlueSpot, flashlight, acoustic warning reverse gear, etc.) (option) during all work and when transporting or moving the machine.
- When moving the machine, all working units must be switched off.
- Use the brake button in case of danger.
- Danger of tilting over when driving on excessively steep slopes
Cleaning on slopes of up to 6 % (standard drive) or 15 % (X-AC drive) must only take place for a limited period of time and with special caution.

**Note**

- The machine can only be put into service when the driver is sitting on the driver's seat.
- The travel drive can only be started if the accelerator pedal is not being actuated when the machine is turned on.
- After turning on the machine, the driving direction selection is in neutral.

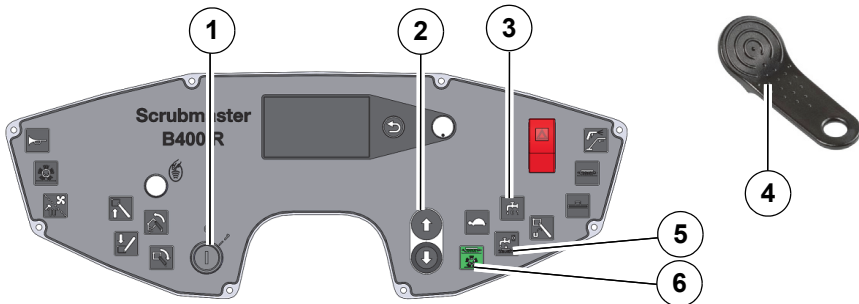
**Fig. 24**

- 1 Key switch
- 2 Button *Driving direction selection*
- 3 Button *Fresh water supply*
- 4 I-Button (option)
- 5 Button *Boost function*
- 6 Button *Clean On*

1. Turn the machine on with the key switch **Fig. 24-1**.
2. Use the *Driving direction selection* button **Fig. 24-2** to select the driving direction.
3. Select the cleaning program with the *Clean On* button **Fig. 24-6**.
4. Actuate the accelerator pedal. The rotating brush unit and the water supply are switched on with the last selected setting.
5. If necessary, switch on the fresh water supply **Fig. 24-3**.
6. Set the fresh water quantity on the multifunction display using the soft key *Fresh water dosing*.
7. In the event of heavy soiling, increase the brush pressure using the soft key *Brush pressure* on the multifunction display or press the *Boost function* button **Fig. 24-5** (increased cleaning power for 1 minute).

3.4.1 entry.X (option)

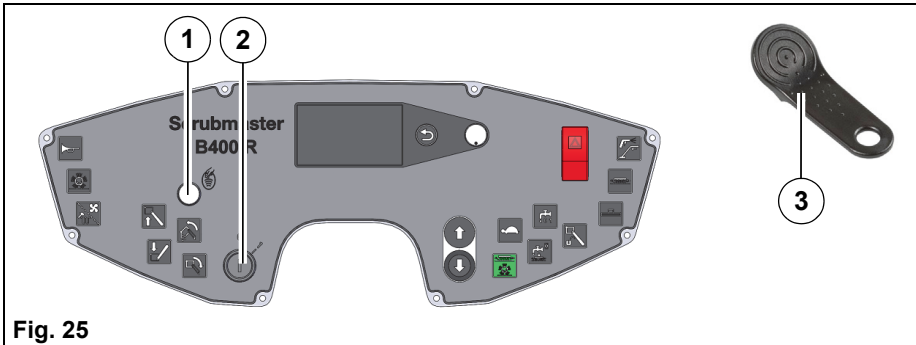

Fig. 25

- 1 I-Button Reader (option)
- 2 Key switch
- 3 I-Button (option)

Access authorization is allocated using entry.X. Entry.X can only be used with view.X.live.

Putting into service

1. Turn the machine on with the key switch **Fig. 25-2**.
 - Red LED of the I-Button Reader ON.
2. Press the I-Button **Fig. 25-3** for one to two seconds against the I-Button Reader **Fig. 25-1**.
 - Red LED OFF.
 - The operating data recording system is active.

If the machine is **not** registered with the I-Button, the following condition arises according to the selected option:

Access authorisation	Indicator LED	Machine function
without limitation (50EC001)	Red LED ON	Fully functional
with lock (50EC002)	Red LED ON	Function of the working tools is locked, transport is possible



Note

A red illuminated LED is a request for activation of the operating data recording system via the I-Button!

Ending operation

Turn the machine off with the key switch.

3.4.2 On-board dosing system (option)

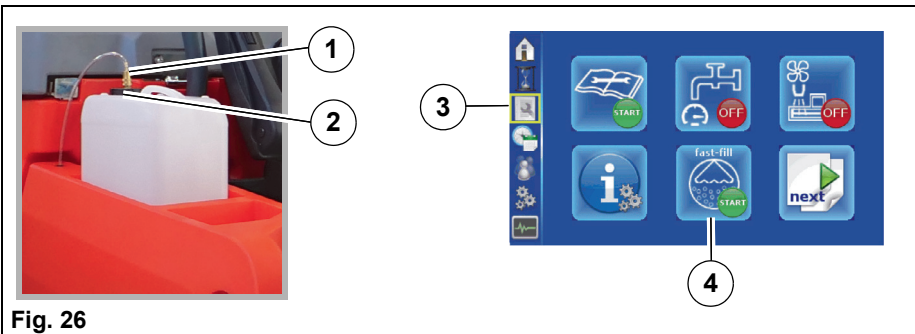

Fig. 26

- 1 Quick coupling
- 2 Cap with tube
- 3 Sub-menu *Maintenance*
- 4 Menu *Fast fill*

The on-board dosing system is used for optimum dosing of the detergent.



Attention

- Only use detergents suitable for automatic machines (foam retarded). We recommend use of our cleaning and care agents specifically developed for the machines. These products meet the requirements of the German Detergent and Cleaning Agent Act (WRMG).

Putting into service

The following points must be run through for putting into service and after every canister change.

1. Release the quick coupling **Fig. 26-1** at the canister lid by pulling the lower ring of the coupling upwards.
2. Unscrew the lid from the canister and replace the canister.
3. Screw on the lid with integrated tube **Fig. 26-2** and fit the quick coupling with hose.
4. Turn the machine on with the key switch.
5. In the sub-menu *Maintenance* **Fig. 26-3**, select the *Fast fill* menu **Fig. 26-4** with the turn-push knob and confirm.

When the program is started, the detergent is conveyed to the brush unit by means of the dosing pump.

The program finishes automatically.

The on-board dosing system is ready for operation.

Setting the mixing ratio

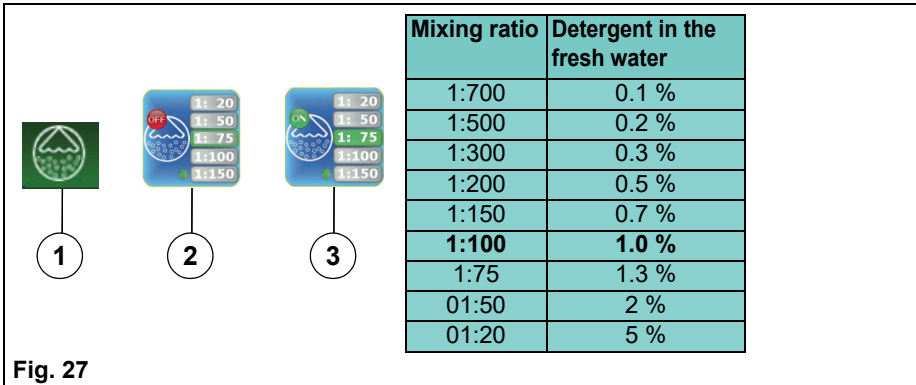

Fig. 27

- 1 Button *On-board dosing system*
- 2 Mixing ratio selected
- 3 Mixing ratio confirmed

In the action window, the mixing ratio of detergent/fresh water can be selected in 9 steps. Basic setting = 1:100

1. Turn the machine on with the key switch.
2. Select the soft key *On-board dosing system* **Fig. 27-1** with the turn-push knob and confirm.
3. **Turn on:**
Set the desired mixing ratio **Fig. 27-2** and confirm with the turn-push knob. The set mixing ratio is displayed with a green background **Fig. 27-3**.
Change:
Set the desired mixing ratio. The value is accepted automatically.
Turn off:
Press the turn-push knob.

3.4.3 Useful cleaning tips

Before starting wet cleaning, it is necessary to sweep the floor (basic version of the Scrubmaster B400 R). This not only enhances the cleaning effect but also reduces wear of the machine's working tools.

If the floors are really dirty or wax needs to be removed, treat the floor twice. In the first step, scrub the floor with a detergent suitable for the degree of soiling; the side wipers must be raised and the squeegee switched off for this purpose.

Leave the detergent for approx. 5 to 10 minutes; subsequently scrub the floor again with lowered side wipers and vacuum with the squeegee.



Note

- Only use detergents suitable for automatic machines (foam retarded). We recommend use of our cleaning and care agents specifically developed for the machine. These products meet the requirements of the German Detergent and Cleaning Agent Act (WRMG).
- Observe correct dosing of the detergent. Correct dosing saves money and protects the environment. Strong foam formation is a sign of excessive dosing and impairs machine operation.

3.4.4 Handling and braking the vehicle



Danger

- Danger of tilting over when driving on excessively steep slopes. Transport on slopes of up to 10 % (standard drive) or 18 % (X-AC drive) must only take place for a limited period of time and with special caution.
- Drive slowly on wet surfaces, particularly in bends, due to the risk of skidding.
- When driving uphill, downhill or across slopes, avoid sudden turns and drive slowly into the bend.



Note

Set the key switch to '0' to immediately disable all the functions.

Observe the following points when driving:

- Adapt the driving speed to the ambient conditions, the local conditions and the load condition of the machine.
- Driving speed and braking of the machine are controlled via the accelerator pedal.
- The engine brake is automatically applied when the accelerator pedal is released. This also applies when ascending or descending.
- Stop the machine: Release the accelerator pedal. Press the brake button for maximum deceleration.
- When the machine is at standstill, the parking brake is activated automatically. It is no longer possible to push the machine.

Overload protection

In case of an overload, e.g. excessively steep slopes, the drive motor is switched off after a certain period of time.

- Let the machine cool down for approx. 15 minutes.
- Restart the machine.

3.4.5 Towing the machine



Danger

Risk of accident! When towing the machine, it does not have any braking effect.

Only tow the machine with a towbar!

If the machine stops on an uphill or downhill gradient, call the towing service or a Hako service workshop!



Attention

Before towing, the brakes must be unlocked.

Releasing the parking brake on machines with a charged battery

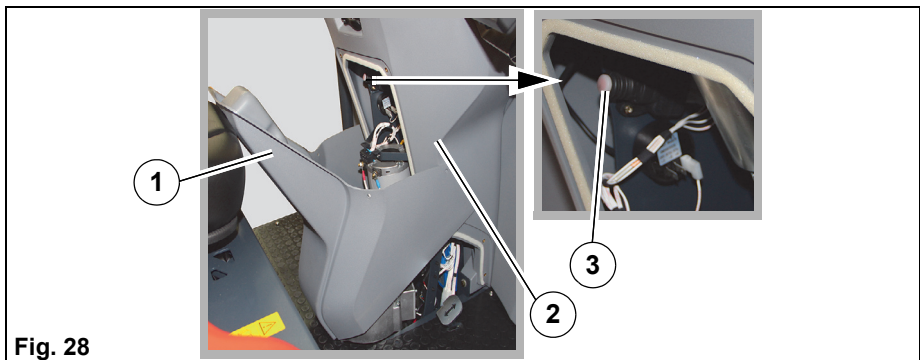

Fig. 28

- 1 Steering column cover swivelled to the rear
- 2 Steering column enclosure
- 3 *Unlock brake* button (standard drive)

In order to tow the machine, carry out the following steps first:

1. Remove the bolts of the steering column cover using the supplied hexagon socket wrench and swivel the upper part of the cover to the rear **Fig. 28-1**.
2. Press the *Unlock brake* button **Fig. 28-3**.
The brake is unlocked electrically.
3. If the machine has an X-AC drive, the rear wheel brake must also be unlocked, see section "*Releasing the rear wheel brake with an X-AC drive*".
4. The machine can now be moved.

Releasing the parking brake on machines without or with an empty battery

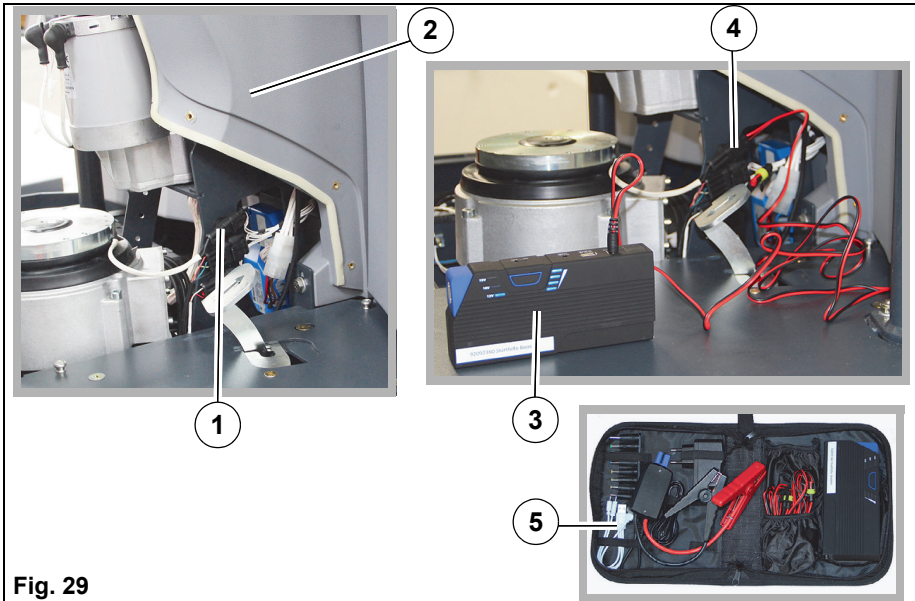

Fig. 29

- 1 2-pin plug of the travel drive
- 2 Steering column enclosure
- 3 Power bank
- 4 Power bank plug connected
- 5 Power bank (kit)

If the machine's battery is deeply discharged or missing, the parking brake must be unlocked by means of a voltage source. A power bank (customer service kit 97501225) with a suitable connection cable is available from the Hako spare parts service for this purpose. The following steps must be carried out:

1. Loosen the bolts of the steering column cover using the supplied hexagon socket wrench and remove the cover.
2. Disconnect the top 2-pin plug of the travel drive **Fig. 29-1**.
3. Connect the power bank plug **Fig. 29-4** to the plug of the travel drive.
4. Switch on the power bank and set it to 19 V. To do so, press the push button until the 19 V range is selected.

The parking brake is released audibly.

5. If the machine has an X-AC drive, the rear wheel brake must also be unlocked, see section "*Releasing the rear wheel brake with an X-AC drive*".
6. The machine can now be moved.

Releasing the rear wheel brake with an X-AC drive

If the machine has an X-AC drive, the rear wheel brake must also be unlocked.

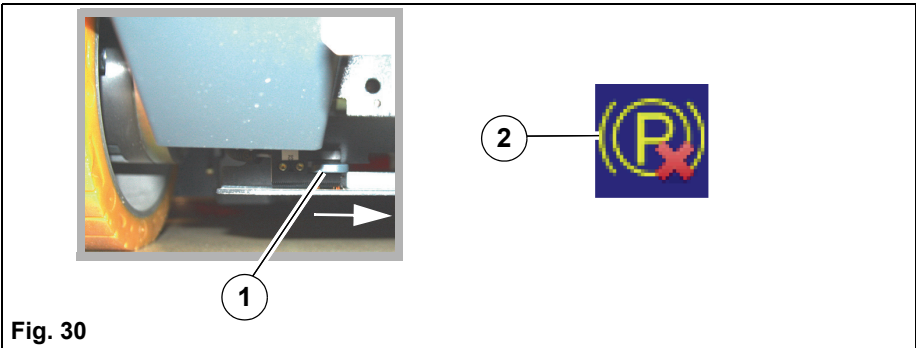

- 1 Unlock the brake lever (X-AC drive)
- 2 *Rear wheel parking brake is not operational* symbol

Push the lever at the rear on the left side of the machine **Fig. 30-1** from left to right until it engages.

Indication appears on the multifunction display **Fig. 30-2** when the rear wheel brake is out of service. The machine can no longer be driven!

Restart the rear wheel brake in reverse order.



Note

With an X-AC drive (option), the rear axle brake locking lever must be swivelled back to its original position. The machine is secured against rolling away.

Towing the machine

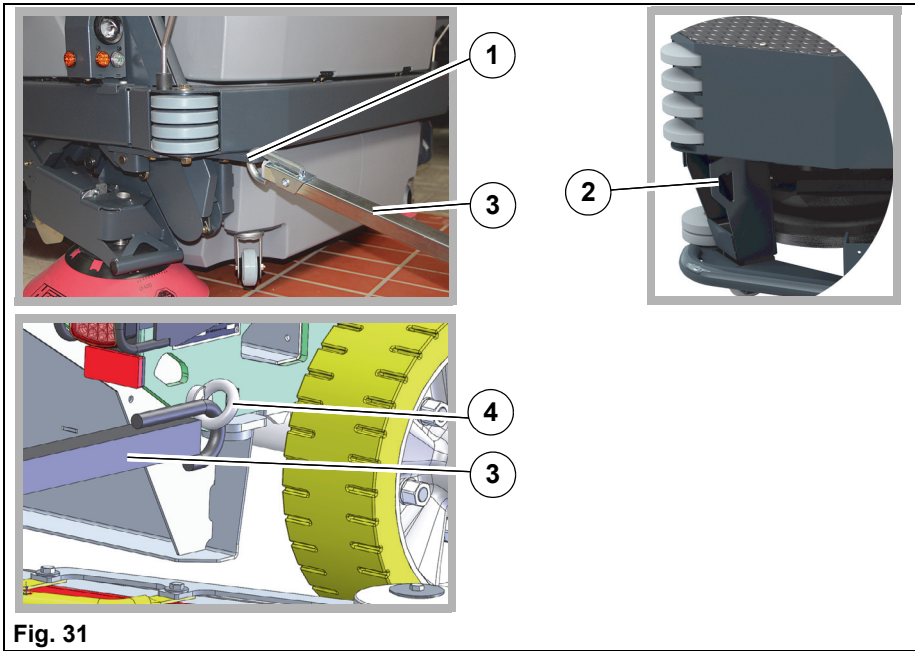

Fig. 31

- 1 Towing coupling (front) installed (B400 RM/RH)
- 2 Towbar attachment point, front (B400 R)
- 3 Towbar (not included in the scope of supply)
- 4 Towing eye (rear) installed

Note



A towing coupling must not be installed at the front of the Scrubmaster B400 R. In this case, the attachment point **Fig. 31-2** is used.

1. Install the front towing coupling **Fig. 31-1** or the rear towing eye **Fig. 31-4** from the customer service kit 97501125 (available from the Hako spare parts service) as specified.
2. Hook in the towbar **Fig. 31-3** (not included in the scope of supply).
3. Unlock the parking brake, see sections above.
4. At machines with an X-AC drive, release the rear brake, see section above.
5. Tow the machine.
6. Returning the machine to its original state takes place in reverse order.

3.4.6 Turning off the machine

**Danger**

- Danger due to uncontrolled movement.
The machine must not be parked on slopes greater than 10 % (standard drive) or 15 % (X-AC drive).

1. Slowly bring the accelerator pedal to the zero position.
The machine slows down to standstill. A stronger braking effect is achieved by pressing the brake button. When the machine is at standstill, the parking brake is activated automatically.
2. Switch off the cleaning functions.
3. Turn off the machine with the key switch.

**Note**

Remove the key when leaving the machine to prevent unauthorised use.

3.4.7 Check list: After cleaning

	Warning	<ul style="list-style-type: none"> • Turn off the machine and remove the key when leaving the machine to prevent unauthorised use. • After use, park the machine in a dry, indoor location with the working units raised.
	Attention	<ul style="list-style-type: none"> • Do not use a strong water jet, a high-pressure cleaner or steam jet to clean the machine.
	Environmental danger	Observe the applicable laws and local regulations when disposing of detergents.

	Description	Section
1	Drive to a suitable maintenance location.	
2	Clean the plate filter (B400 RM/RH only).	5.10.2
3	Empty the dirt hopper (B400 RM/RH only).	5.7
4	Turn the machine off and remove the key.	
5	Empty and clean the waste water tank.	5.4.1 5.4.2
6	Check the fresh water filter and clean if necessary.	5.5
7	Check the sealing strips and suction hose.	5
8	Check the functions and settings.	
9	Charge the battery.	5.2.2
10	Clean the machine. If the machine is not used the next day, the solution tank must be fully emptied.	5.3.2

3.5 Loading and transporting



Attention

- When loading and subsequently transporting the machine to the work site, the working units must be switched off and in the raised position. The tank and dirt hopper must be emptied.
- Remove the squeegee before driving on loading ramps.
- Risk of skidding! Drive very carefully and only on dry ramps.
- When loading the machine, reverse it (empty drive) up the ramp (maximum slope 18 %).

Loading

When loading the machine, observe its weight, see section 4 *Technical data* on page 100.

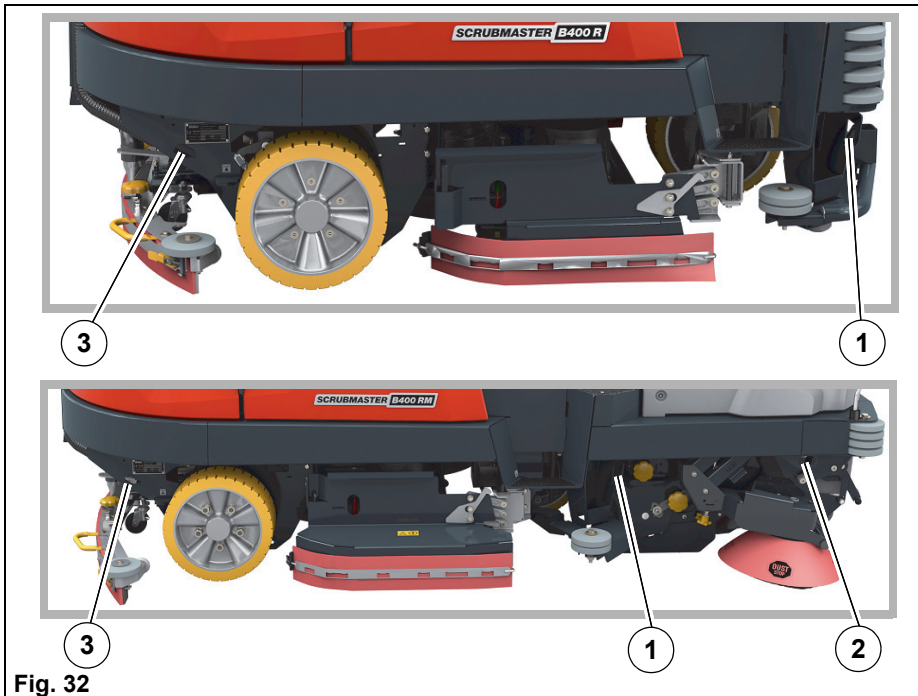

Fig. 32

- 1 Main attachment point B400 R/RM/RH
- 2 Main attachment point support B400 RM/RH
- 3 Attachment points on the rear of the machine B400 R/RM/RH

Transporting



Danger

- Danger due to uncontrolled movement. When transported on a vehicle or trailer, the machine must be secured against tilting and rolling away. During transport, the machine must be shut down and properly lashed down.

B400 R:

To do this, securely lash the machine at both sides at the front **Fig. 32-1** and the rear **Fig. 32-3** with tension straps.

B400 RM and RH:

To do this, securely lash the machine at both sides in the middle **Fig. 32-1** and the rear **Fig. 32-3** with tension straps. In addition, lash the machine on both sides at the supporting attachment points **Fig. 32-2** with tension straps.

3.6 Service information

In case problems occur with the machine, a four-digit service code is output in the display panel in addition to the service indicator (tool key). The table below explains the most important service codes. If the cause cannot be eliminated and for all service codes not listed here, notify your authorised Hako dealer or your Hako service workshop.

If the cause has been eliminated, the fault must be acknowledged via the key switch OFF/ON.

Service code	Fault	Cause	Remedy
1.2.5.1/ 1.2.5.2/ 1.2.5.5	Brushes stop	Foreign particles between brush and shaft	Inspect the brushes for foreign particles and remove them if necessary
1.2.6.1/ 1.2.6.8/ 1.2.6.2	Brushes stop	Foreign particles block the brush	Inspect the brushes for foreign particles and remove them if necessary
		Brush not positioned correctly in the holder	Actuate the brush decoupling system, contact the service partner, if necessary
1.2.6.3	Brush lift system, brush and suction turbine have been switched off	Foreign particles between brush unit and machine	Inspect the brush unit for foreign particles and remove them if necessary
		Brush unit stuck	Release brush unit
1.4.6.1	Squeegee lift system stops	Overload due to foreign particles	Inspect for foreign particles and remove them if necessary
		Foreign particles between squeegee and machine	Inspect the lift system for foreign particles and remove them if necessary
		Squeegee jammed	Make the squeegee accessible
1.4.6.3/ 1.4.6.4	Suction turbine stops	Foreign particles in the suction turbine	Notify Hako service workshop
		Faulty suction turbine	
1.5.5.1	Fresh water level not displayed	Sensor error	Notify Hako service workshop

Service code	Fault	Cause	Remedy
1.5.5.3	High-pressure cleaner switches off	Overheating due to excessively long use	Let the high-pressure cleaner cool down for 40 min, then restart it
		No water supply	Switch on the water supply
2.2.5.1/ 2.2.6.1/ 2.2.6.2	Sweeping roller stops	Foreign particles block the brush	Inspect the sweeping roller for foreign particles and remove them if necessary
2.3.5.1/ 2.3.6.1/	Side brooms stop	Foreign particle blocks the side brooms	Inspect the side brooms for foreign particles and remove them if necessary
3.1.6.E	Cleaning function no longer possible	Electrical defects	Notify Hako service workshop
3.2.6.5/ 3.2.6.6	Service code indicator when turning on the machine	Low capacity of the internal back-up battery of the machine control or discharged	Notify Hako service workshop. Machine can still be used.
3.3.1.1	Service interval expired		See maintenance plan
3.4.1.1	Speed control	Driving direction selection not recognised or implausible	Machine OFF/ON
3.4.1.2/ 3.4.1.4	Driving not possible	Error in the drive control	Machine OFF/ON, or notify Hako service workshop if necessary
3.4.5.1/ 3.4.5.2	Cleaning function switches off	Drive wheel becomes sluggish due to foreign particles	Remove foreign particles
		Drive motor overheats	Let the engine cool down
3.6.6.4	Driving and cleaning not possible	Seat permanently loaded	Relieve seat

Service code	Fault	Cause	Remedy
4.2.1.4	Dosing system not working	Dosing pump defect	Notify Hako service workshop
5.2.6.1	Faulty signal for charging state measurement	Cables on the battery poles loose or detached	Contact the customer service
		Incorrect type of battery installed	Install correct battery
7.1.5.1	USB connection not working	Connected consumer overloaded	Check whether the consumer is drawing too much power or there is a short-circuit in the connected cable
		Internal controller defect	Notify Hako service workshop

4 Technical data

Dimensions

Name	Unit	B400R	B400 RM	B400 RH
Machine length	mm	2020	2810	2810
Machine width: with rotating brush 1230 with rotating brush 1550 (Side collision protection option: + 10 cm each)	mm		1300 1600	
Height of machine without/with overhead guard	mm		1500/2120	

Working width

Name	Unit	B400R	B400 RM	B400 RH
Rotating brush unit: Rotating brush 1230 Rotating brush 1550	mm		1230 1550	
Squeegee: Rotating brush 1230 Rotating brush 1550	mm		1360 1660	
Pre-sweep suction unit with side broom (sweeping path): Rotating brush 1230 Rotating brush 1550	mm			1520 1680

Weights

Name	Unit	B400R	B400 RM	B400 RH
Weight when empty (without batteries, water, driver, dirt and options) Rotating brush 1550:	kg	820	990	1130
Weight with batteries (without water, driver, dirt and options) Rotating brush 1550:	kg	1730	1900	2040
Permissible total weight (without options)	kg	2210	2440	2610

Driving performance

Name	Unit	B400 R	B400 RM	B400 RH
Driving speed (standard): Transport and cleaning Forwards (standard / X-AC) Reversing	km/h	9/9 4	8/9 4	
Driving speed (StVZO option): Transport and cleaning Forwards (standard / X-AC) Reversing	km/h		8/8 4	
Climbing capacity when cleaning: Front-wheel drive X-AC drive	%		6 (2 min.) 15 (up to 3 min. at 4 km/h)	
Climbing capacity during transport (ready for operation): Front-wheel drive X-AC drive	%		10 (1 min.) 18 (2 min at 4 km/h)	
Ramp angle (slope angle) front / rear	%		18/36	
Turning circle in gear: with 3-rotating brush unit 1230 with 3-rotating brush unit 1550	mm	2130 2280	2880 3020	

Wheels

Name	Unit	B400 R	B400 RM	B400 RH
Wheel diameter front/rear	mm	350		
Specific wheel contact (ready for operation with driver): front rear	N/mm ²	0.84 0.80	1.15 0.82	1.16 0.77

Solution/Waste water tank

Name	Unit	B400 R	B400 RM	B400 RH
Solution tank (with empty waste water tank)	Litre	400		
Waste water tank (with empty solution tank)	Litre	400		
Tank concept		Flex wall		
Fresh water volume with auto filling	Litre	388		
Duration for filling the tank with auto filling	Min.	24		
Water supply	l/min	3 to 9		

Rotating brush units

Name	Unit	B400 R	B400 RM	B400 RH
Number of rotating brushes	Qty.	3		
Speed of rotating brushes	rpm	220		
Brush contact pressure normal/stage1/stage2 3-rotating brush unit 1230 3-rotating brush unit 1550	kg	55 / 75 / 95 80 / 110 / 140		
Diameter of rotating brush: Rotating brush 1230 Rotating brush 1550	mm	430 530		
Theoretical sweeping capacity: Rotating brush 1230 - Standard - X-AC Rotating brush 1550 - Standard - X-AC	m ² /h	11,100 11,100 14,000 14,000	9,800 11,100 12,400 14,000	

Vacuum system

Name	Unit	B400 R	B400 RM	B400 RH
Air quantity suction turbines (maximum)	m ³ /h	258		
Vacuum (maximum)	mbar	180		

Electrical system

Name	Unit	B400 R	B400 RM	B400 RH
Nominal voltage	V	36		
Battery capacity: Small battery Large battery	Ah	540 810		
Battery life with battery 810 Ah: Rotating brush 1230 Rotating brush 1550	h	8.0 7.1	7.1 6.4	
Maximum total rated input: Rotating brush 1230 Rotating brush 1550	kW	13.4 14.7	14.7 16.0	
Power consumption drive motor (P1): Front-wheel drive X-AC drive front/rear	kW	5.8 9.0		
Power consumption vacuum motor (P1) Suction turbines:	kW	1.3		
Power consumption brush motor (P1) 3-rotating brush unit 1230 3-rotating brush unit 1550	kW	2.8		
		4.1		
Sweeping roller		0.8		
Side broom		0.2		
Power consumption water pump (P1)	kW	0.1		
Type of protection		IPX 3		
Protection class		III		

Pre-sweep suction unit

Name	Unit	B400 RM	B400 RH
Sweeping roller width	mm	880	
Sweeping roller diameter, new / worn	mm	250/190	
Sweeping roller speed	rpm	510	
Sweeping level width	mm	50	
Side broom diameter: Rotating brush 1230 Rotating brush 1550	mm	400 455	
Side broom speed	rpm	100	
Gross dirt hopper volume	Litre	88 (2x44)	150
Maximum dirt weight	kg	100 (2x50)	130
Lift height of dirt hopper	mm		1660
Filter area	m ²	1.6	
Filter dust class (IEC 60335-2-69)		L	
optional		M / H	

Noise emission value
B400 R

		with rotating brush unit	
		Standard operation	Silent operation
The sound power level (L_{wAd}) measured under the customary conditions of use according to DIN EN 60335-2-72 is:	dB (A)	85	
The sound pressure level (L_{pA}) (at the ear of the driver) measured under the customary conditions of use according to DIN EN 60335-2-72 is:	dB (A)	68	
Measuring uncertainty (K_{pA})	dB (A)	2	

B400 RM/RH

		with rotating brush unit		with pre-sweep suction unit	
		Standard operation	Silent operation	Standard operation	Silent operation
The sound power level (L_{wAd}) measured under the customary conditions of use according to DIN EN 60335-2-72 is:	dB (A)	85		88.7	
The sound pressure level (L_{pA}) (at the ear of the driver) measured under the customary conditions of use according to DIN EN 60335-2-72 is:	dB (A)	68		74	
Measuring uncertainty (K_{pA})	dB (A)	2		2	

Vibration

Under the customary conditions of use, the weighted effective value of the acceleration to which the upper limbs (hand-arm) are subjected to according to DIN EN ISO 5349 is:	m/s^2	< 2.5
Under the customary conditions of use, the weighted effective value of the acceleration to which the body (feet or seat surface) is subjected to DIN EN ISO 2631-1 is:	m/s^2	< 2.5

5 Maintenance and servicing



Warning

- Daily and weekly maintenance work must be performed in accordance with the maintenance plan by trained operators. For all other maintenance work, please contact your nearest Hako service workshop.
- The maintenance work and maintenance intervals specified in the operating manual and service booklet must be complied with.
- Suitable tools and protective clothing such as protective gloves and safety shoes must be used during cleaning, repair and maintenance work.
- Have the machine checked for safe condition by an expert in accordance with the accident prevention regulations at appropriate intervals (we recommend at least once yearly).
- Spare parts must at least comply with the technical requirements specified by the manufacturer. This is guaranteed by original spare parts.
- Turn the machine off, remove the key and disconnect the battery plug when cleaning and maintaining the machine and before replacing parts.
- Cleaning the machine with a water jet, high-pressure cleaner or steam jet is not permitted!
- Only put the machine into service when all the protective devices are attached and in protection position.
- Do not perform any welding, drilling, sawing or grinding work on parts of the frame. Have damaged parts replaced by a Hako service workshop.



Attention

- Application of aggressive and corrosive detergents for cleaning the machine is not allowed.



Note

- After cleaning, let the machine air dry, e.g. over the weekend. To do this, leave the tank cap open.
- The maintenance work and maintenance intervals specified in the operating manual must be complied with.

General

The operator is instructed fully on delivery of the machine.

Compliance with the maintenance work recommended by us gives you the certainty of always having an operational machine available.

Daily and weekly maintenance work can be performed by an operator trained for this purpose. For all other maintenance work, see the service booklet, please contact your nearest Hako service workshop or your authorised Hako dealer.

Any warranty claim is null and void if this is not complied with and damage results.

Please always state the vehicle identification no. in all enquiries and spare parts orders, see section 1.9 *Labels on the machine* on page 24 – type plate.



Note

- Maintenance parts in the machine are marked in yellow.
- The maintenance instructions can also be called up on the multifunction display in the form of pictures, see section 2.3.3 *Sub-menu* on page 57 – *Maintenance* menu.

5.1 Maintenance plan

Hako system maintenance customer:

Work to be performed by the customer by reference to the servicing and maintenance instructions specified in the operating manual.

Daily	Section
<ul style="list-style-type: none"> • Flex wall tank: <ul style="list-style-type: none"> • Empty and clean the waste water area. • Check and clean the solution drain hose seal. • Check and clean the waste water drain hose seal. • Clean the coarse dirt sieve. • Clean the intake sieve. • Check the cap seal of the flex wall tank, clean if necessary. 	5.4.1 / 5.4.2 5.3.4 5.4.5 5.4.3 5.4.4 5.4.6
<ul style="list-style-type: none"> • Battery: <ul style="list-style-type: none"> • Check the battery charge. • Charge the battery. 	5.2.1 5.2.2
<ul style="list-style-type: none"> • Check the squeegee and clean if necessary. 	5.11.1
<ul style="list-style-type: none"> • Check the suction hose for tight fit, damage and clogging, replace or clean if necessary. 	
<ul style="list-style-type: none"> • Check the rotating brushes/pads for wear and foreign particles, replace or clean if necessary. 	5.6.2
<ul style="list-style-type: none"> • Water treatment (option) Clean the filter. 	
<ul style="list-style-type: none"> • Pre-sweep suction unit (B400 RM/RH only): <ul style="list-style-type: none"> • Clean the plate filter. • Empty the dirt hopper and clean if necessary. • Clean the sweeping roller and the sweeping roller compartment. • Check the dirt hopper seals and clean if necessary. • Visually inspect the V-belt of the sweeping roller. 	5.10.2 5.7 5.8.2

Weekly	Section
<ul style="list-style-type: none"> • Clean the machine as required. 	
<ul style="list-style-type: none"> • Clean the solution tank. 	5.3.3
<ul style="list-style-type: none"> • Check the sieve insert in the fresh water filter, clean or replace if necessary. 	5.5
<ul style="list-style-type: none"> • Check the rotating brushes and water retaining ring for proper fit and wear, replace if necessary. 	5.6.2 ff
<ul style="list-style-type: none"> • Check the suction performance of the squeegee, clean or replace the sealing strips if necessary. 	5.11.1 ff
<ul style="list-style-type: none"> • Check the fresh water supply to the brushes, clean if necessary. 	
<ul style="list-style-type: none"> • Inspect the wiper rubber of the side wiper for wear and damage, replace if necessary. 	5.12.1
<ul style="list-style-type: none"> • Batteries with Aquamatic system: Check the acid level. 	5.2.3
<ul style="list-style-type: none"> • Pre-sweep suction unit (B400 RM/RH only): <ul style="list-style-type: none"> • Check the sweeping roller for wear, readjust or replace if necessary. • Check the side broom for wear, readjust or replace if necessary. • Clean the plate filter. • Check the chain tension of the tilt device. 	5.8.5 5.8.1 5.9.2 5.9.1 5.10.2
<ul style="list-style-type: none"> • Battery changing system (option): <ul style="list-style-type: none"> • Check proper functioning of the locking mechanism. • Check the rollers on the battery changing rack and on the Scrubmaster for ease of movement. • Check proper condition and functioning of the rope, threaded rod, locking lever, tension spring and positioning aid. • On the Scrubmaster, check proper condition and functioning of the manually operated locking device and automatic battery locking device. 	6.7
<ul style="list-style-type: none"> • Pre-sweep suction unit especially for high dump (B400 RH only) <ul style="list-style-type: none"> • Visually inspect hoses, couplings and connecting elements for leaks. • Visually inspect the hydraulic cylinder. • Check the hydraulic oil level, top up if necessary. 	

Weekly	Section
<ul style="list-style-type: none">• On-board dosing system (option): Check section of hose in the dosing pump, replace if necessary.	3.4.2
<ul style="list-style-type: none">• Pre-sweep suction unit especially for high dump (B400 RH only)<ul style="list-style-type: none">• Visually inspect hoses, couplings and connecting elements for leaks.• Visually inspect the hydraulic cylinder.• Check the hydraulic oil level, top up if necessary. If the hydraulic oil level is below the min mark or if leaks are detected, inform the Hako service workshop.	
<ul style="list-style-type: none">• High-pressure cleaner (option) Visually inspect hoses, couplings and connecting elements for leaks.	
<ul style="list-style-type: none">• Water treatment (option) Visually inspect hoses, couplings and connecting elements for leaks.	
<ul style="list-style-type: none">• Trial run and function test	

5.2 Battery

5.2.1 Checking the charging state



Fig. 33

The charge condition of the battery **Fig. 33-2** is displayed on the multifunction display during operation. Depending on the charge condition, the following symbols appear:

Symbols	Charging state	Notes
	Battery is fully charged	
to	Battery capacity is displayed in steps of 10 %	Battery can be charged ≤ 60 %
	Battery capacity less than 10 %	Cleaning functions are switched off after 3 minutes. Charge the battery!
	Battery is empty	Cleaning functions will be switched off. Only travel at half speed is possible. Battery must be fully charged immediately!
	BMS service information. A four-digit service code appears at the same time Fig. 33-1 .	Service information, see section 3.6 <i>Service information</i> on page 97.

5.2.2 Charging the battery



Danger

- Risk of explosion! Explosive gases can develop when charging the battery.
 - Avoid smoking and naked flames in the vicinity of batteries.
 - Swivel up the seat console all the way before charging the battery.
The seat console must remain open when charging the battery!
- Ensure that there is sufficient ventilation when charging the battery.
- Do not place the battery plug on the battery during charging!
- Never place tools or other electrically conductive objects on the battery!
- Only connect and disconnect the battery plug when the charger and the machine are turned off!
- Only connect and disconnect batteries when the machine is turned off.



Attention

- Before initially starting up the machine, the battery that is used must be fully and properly charged with commissioning charge. Please observe the operating manual of the charger and the operating manual of the battery manufacturer. Hako assumes no liability for battery damage resulting from insufficient commissioning charge.
- Make sure the battery is never fully discharged; recharge it as quickly as possible.
- If possible, charge the battery fully to ensure that the battery has an optimum service life. The charger is designed as a continuous charger and retains the charging state of the battery (trickle charge) after completing the charging process.
- The battery should always be charged without being interrupted.
- During the charging process it is not possible to turn on the machine.
- Observe the information in the instruction manual of the charger and of the battery manufacturer!

Charging the battery with a stationary charger

Charge the batteries with a stationary charger as, for example, shown in **Fig. 34-1**. The batteries should be charged if the battery capacity is less than 60 %.



Note

For safe charging, the Hako charger and the battery have a safety circuit (pilot contact control unit).

The charger (99746410) can only charge batteries that have the PCCU circuit **Fig. 34-2**.

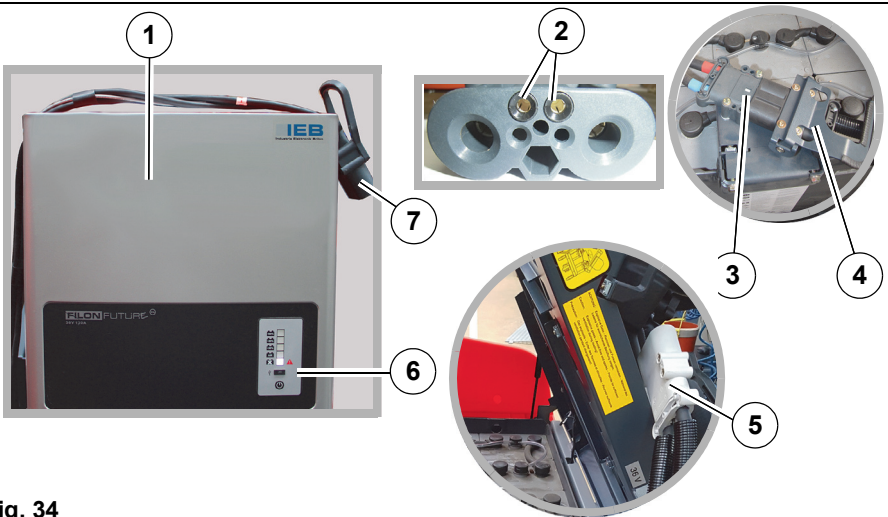

Fig. 34

- 1 Charger
- 2 Safety circuit (pilot contact control unit PCCU)
- 3 Battery socket
- 4 Machine plug
- 5 Machine plug position, charging process
- 6 Charger indicator
- 7 Charger plug

1. Park the machine on a level surface, turn it off and remove the key.
2. Fold up the seat console to the front and leave it open during the charging process!
3. Remove the machine plug **Fig. 34-4** from the battery socket **Fig. 34-3**.
4. Hook the machine plug into the seat console **Fig. 34-5**.
5. Plug the charger plug **Fig. 34-7** into the battery socket **Fig. 34-3**.

6. Switch on the charger.
7. The progress of the charging process is displayed on the indicator **Fig. 34-6** of the charger.
8. Once the battery is fully charged, terminate the charging process:
 - Turn off the charger and wait approx. 15 minutes with the seat console open.
 - Remove the charger plug from the battery socket. Plug the machine plug **Fig. 34-4** back into the battery socket **Fig. 34-3**.

5.2.3 Checking the acid level

The customer must check the acid level of the batteries once a week.



Danger

Risk of explosion and fire! When handling batteries, it is prohibited to smoke and use an open fire.

Attention

- Observe the information in the operating manual of the battery manufacturer!
- Refilling must only take place once the battery charging process has been terminated.



Note

Batteries approved by Hako are equipped with an aquamatic system.

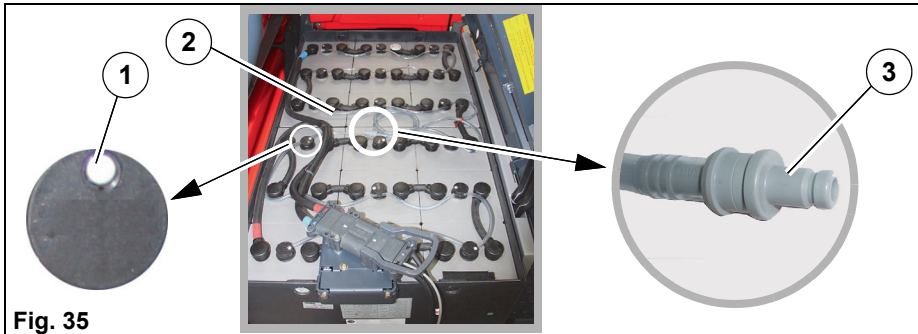

Fig. 35

- 1 Float indicator
- 2 Aquamatic system
- 3 End piece of aquamatic system

Checking the acid level:

If the trough battery is equipped with an aquamatic system **Fig. 35-2**, each individual cell features a sealing plug with float indicator.

The white dot must be located at the top and must be clearly visible. If this is not the case, refill demineralised water according to DIN 43530-4.

Topping up with demineralised water:

Connect the end piece of the aquamatic system **Fig. 35-3** to a container with demineralised water. Observe sufficient gradient, ensuring the water can flow into the cells. Once the required filling level has been reached, the plugs automatically seal the cells and indicate “full” **Fig. 35-1**.

5.2.4 Changing the battery



Warning

- Only use batteries approved by Hako at the intended position!
- The battery should only be changed by trained operating staff!
- Wear safety shoes and protective gloves when changing the battery.
- When raising and lowering the battery trough with a crane, there is a risk of injury from falling and uncontrolled swinging parts.
 - The operator must be instructed by the owner in the operation of the crane and informed of the risks associated with its operation.
 - Only use the attachment points provided.
 - When changing the battery trough, use a suitable battery changing cross-beam (according to VDI 3616) and sufficiently load-bearing crane gear.
 - Do not hook in the chains at too shallow an angle, otherwise the tensile forces in the chains can increase to several times the weight of the battery and the chains may break.
 - Do not lower or place lifting gear and chains (according to VDI 3616) on the battery cells.
 - Never use damaged crane gear.
 - Lifting hooks should not cause damage to battery cells, connectors or connecting cables.
 - Keep a sufficient distance from the battery trough.
 - Attach the crane hook ensuring it is centred over the battery trough.
 - Carefully lift the battery trough and ensure that the battery trough does not tip over. Change the attachment point if necessary.
- When using other batteries which have been approved by Hako, the BMS must be reset to protect the battery against total discharge. The settings of the BMS must only be carried out by a Hako service workshop!

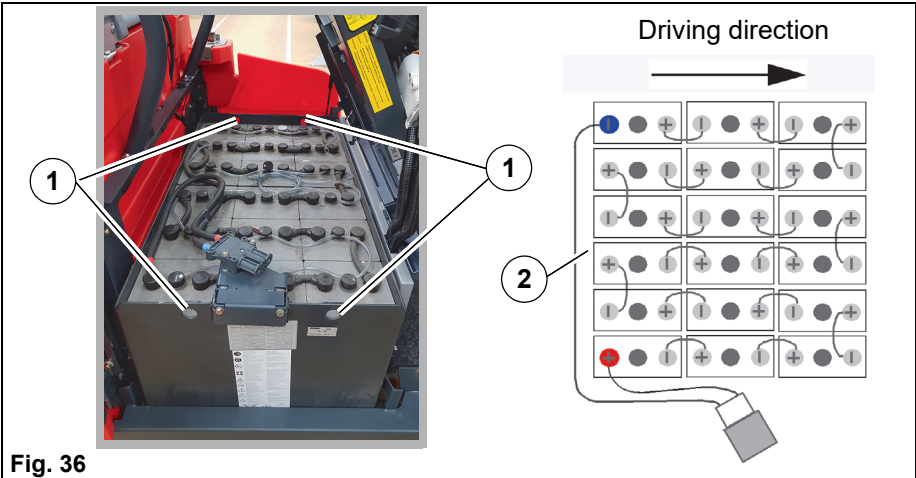

Fig. 36

- 1 Eyelets for crane gear
- 2 Connection diagram

Changing the battery – standard

1. Park the machine on a level surface, turn it off and remove the key.
2. Release the locking device on the right side door of the machine and then open the side door.
3. Open the seat console all the way.
4. Remove the machine plug.
5. Hook the machine plug into the seat console **Fig. 34-5**.
6. Hook the lifting gear of the battery changing cross-beam into the eyelets of the battery trough **Fig. 36-1**.
The lifting gear must carry out a vertical pull so that the battery trough is not distorted.
7. Slowly lift the battery trough upwards and swivel out to the side.
8. Place the battery trough on a level surface.
9. Modify the clamp if necessary, see section *Modifying the clamp*.
10. To fit the battery, follow the instructions in the reverse order.



Note

Please ensure that the battery trough is in the correct installation position! See connecting diagram **Fig. 36-2**.



Note

Information on handling the battery changing system, see section 6.7 *Battery changing system* on page 157.

Installing the clamp (initial start-up)

If the Scrubmaster is delivered without a battery trough, the clamp for the battery socket must be installed before the machine is started up.

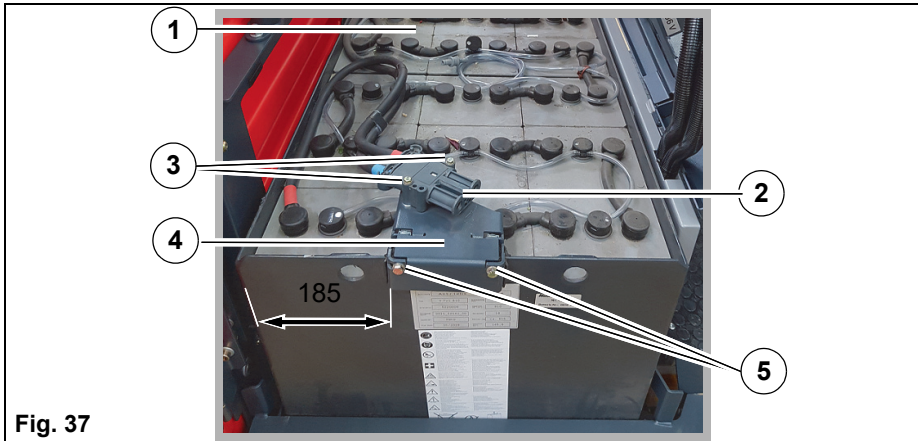

Fig. 37

- 1 Battery trough
- 2 Battery socket
- 3 Battery socket screws
- 4 Clamp
- 5 Clamp bolts

1. Open the seat console all the way.
2. Loosen the cable ties and remove the machine plug and clamp on the seat console.
3. Hook the machine plug into the seat console **Fig. 34-5**.
4. Fit the clamp **Fig. 37-4** approx. 185 mm from the rear edge of the battery trough on the battery trough **Fig. 37-1**.
The clamp bolts **Fig. 37-5** rest on the upper edge of the battery trough.
5. Tighten the clamp bolts to a tightening torque of 25 Nm.
6. Remove the two fitted screws **Fig. 37-3** on the clamp.
7. Install the battery socket on the clamp using the two screws. The tightening torque is 5 Nm.

Modifying the clamp

When changing the trough battery, the clamp may also have to be modified.

1. Remove the two screws **Fig. 37-3** to remove the battery socket on the clamp.
2. Undo both clamp bolts **Fig. 37-5** and remove the clamp **Fig. 37-4**.
3. The clamp is installed on the battery trough to be changed as described in steps 4 to 7 in section *Installing the clamp (initial start-up)*.

5.2.5 Battery plug coding

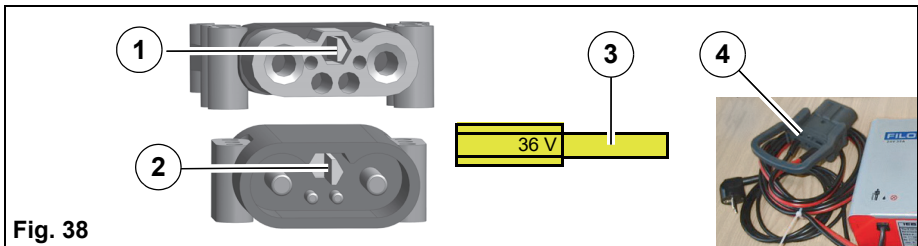

Fig. 38

- 1 Battery socket
- 2 Machine plug
- 3 Coding pin
- 4 Charger plug

When using other batteries which have been approved by Hako, the plugs must be re-coded.

The battery socket **Fig. 38-1**, the machine plug **Fig. 38-2** and the charger plug **Fig. 38-4** are coded with coloured coding pins (yellow, grey or green) **Fig. 38-3** according to the battery type and nominal voltage.

The following three prerequisites must be met for the whole system:

- Voltage coding (36 V) must be identical for all plugs and bushes.
- The colour of the coding pin in the machine plug is always yellow.
- The colour of the coding pin in the charger plug and in the battery socket must be identical:
 - Grey for wet batteries



Warning

Risk of short circuit! The coding of the plugs should only be carried out by a Hako service workshop!

5.2.6 Maintaining drive batteries

For maintaining and servicing drive batteries, see Hako supplementary sheet 88-60-2556 – *Information for drive batteries* and the operating manual of the battery manufacturer.

5.2.7 Taking the machine out of service for a long period

If the battery is not used for more than three months, the battery must be recharged.



Note

Only park unused machines if they are turned off, have a fully charged battery and are placed in a dry location.

5.2.8 Disposing of batteries

Used batteries with the recycling symbol contain reusable commodities. They must not be disposed of in domestic waste, see section 1.8 *Environmental protection instructions and disposal* on page 23.

5.3 Solution tank



- 1 Warning symbol *Solution tank empty*
- 2 Flex wall tank
- 3 Fresh water filling opening cap

The filling level in the solution tank of the flex wall tank **Fig. 39-2** is measured continuously and shown on the multifunction display in steps of 20 %. If there are less than 5 litres in the tank, a warning symbol **Fig. 39-1** appears on the multifunction display. At the same time, an acoustic warning is heard and indicates that a top-up is required.

5.3.1 Filling the solution tank

Fill the solution tank through the filling opening **Fig. 39-3** before commencing work or as required.



Attention

In order to avoid contamination of the drinking water by backflow, the requirements of DIN EN1717 must be adhered to for filling the solution tank.

Filling the solution tank with a hose

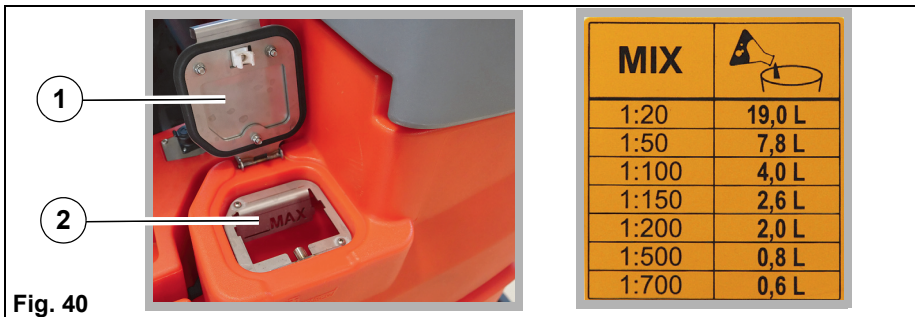

Fig. 40

- 1 Fresh water filling opening cap
- 2 Fresh water filling opening

1. Place the machine on a level surface and turn it off.
2. Open the fresh water filling opening cap **Fig. 40-1** on the left side of the machine.
3. Fill the solution tank three-quarters full (maximum water temperature 50 °C).
4. Add detergent according to the manufacturer's regulations (observe table above).
5. Fill the solution tank with fresh water up to the maximum filling level.
6. Close the cap and snap it into place with a little hand pressure.

Filling the solution tank with the automatic filling unit (option)

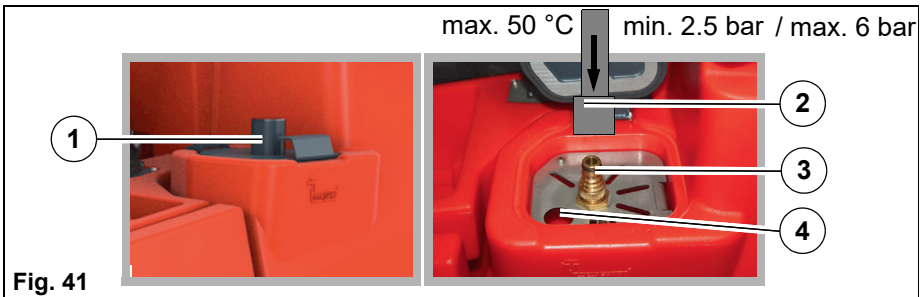

Fig. 41

- 1 Fresh water filling opening cap
- 2 Hose with quick coupling
- 3 Connection for automatic filling unit
- 4 Opening for manual filling

Optionally, the solution tank can be filled via the automatic filling unit.

1. Place the machine on a level surface and turn it off.
2. Open the cap **Fig. 41-1** of the filling opening.
3. Fit the hose with the quick coupling **Fig. 41-2** at the connection **Fig. 41-3**.
4. Open the water supply – water starts to flow.
5. When the tank is full, the filling unit switches off automatically.
6. Close the water supply and remove the hose with the quick coupling.
7. Close the cap and snap it into place with a little hand pressure.



Note

In addition to automatic filling, the machine can also be filled manually through an additional opening **Fig. 41-4**.

5.3.2 Emptying the solution tank

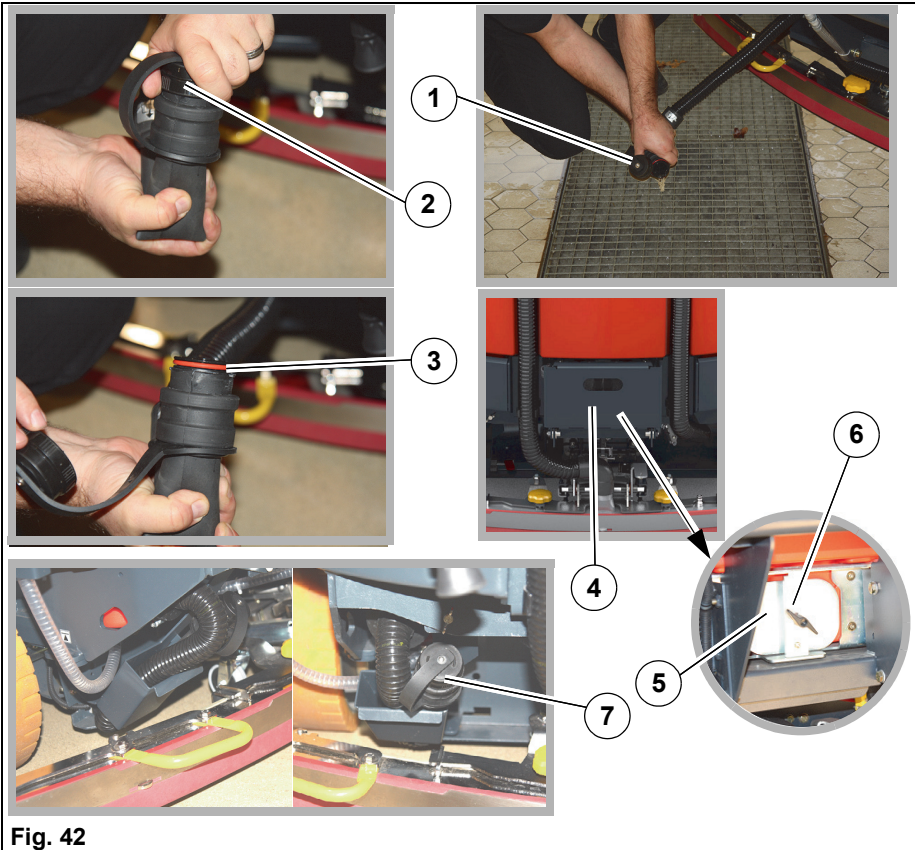

Fig. 42

- 1 Fresh water drain hose
- 2 Drain hose closure
- 3 Drain hose seal
- 4 Step
- 5 Solution tank maintenance cap
- 6 Maintenance opening wing bolt
- 7 Drain hose correctly stowed away

1. Drive to a suitable disposal centre.
2. Park the machine, ensuring the drain hose **Fig. 42-1** reaches the drain in the ground.
3. Turn the machine off and remove the key.
4. Remove the drain hose from the holder.

5. Bend the end of the hose, open the drain hose closure **Fig. 42-2** and empty the solution tank over the drain.
6. Ensure that the drain hose closure is fully closed after draining!
7. Stow away the drain hose correctly in the holder again **Fig. 42-7**.

5.3.3 Cleaning the solution tank

1. Empty the solution tank, see section 5.3.2.
2. Pull up the step **Fig. 42-4** and swivel it to the rear.
3. Undo the wing bolt **Fig. 42-6** at the maintenance cap **Fig. 42-5** and remove the maintenance cap.
4. Thoroughly rinse the solution tank with a water hose through the maintenance opening and then through the filling opening **Fig. 39-3**.
5. Insert the maintenance cap in front of the maintenance opening and fix it into position with the wing bolt.
6. Swivel up the step and let it engage.

5.3.4 Checking the seal at the drain hose



Fig. 43

Check the function of the seal at the drain hose **Fig. 43-1** daily, replace it after 125 operating hours at the latest.

1. Remove the drain hose from the holder.
2. Bend the end of the hose; if there is water in the tank, open the drain hose closure **Fig. 42-2**.
3. Check the seal and replace if necessary.
4. Grease the seal with suitable grease, e.g. Molykote.
5. Ensure that the drain hose closure is fully closed!
6. Stow away the drain hose correctly in the holder again **Fig. 42-7**.

5.4 Waste water tank

5.4.1 Emptying the waste water tank

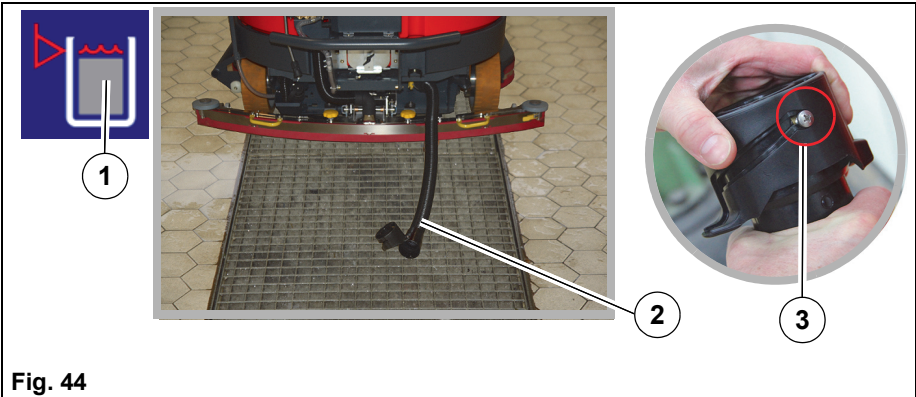

Fig. 44

- 1 Warning symbol *Waste water tank*
- 2 Waste water tank drain hose
- 3 Drain valve closed

Empty and clean the waste water tank **Fig. 45-8** as required but at least once a day. When the warning symbol *Waste water tank full* **Fig. 44-1** appears on the multifunction display and an acoustic warning signal is output, the suction function is switched off and the waste water tank should be emptied immediately.



Environmental danger

Observe applicable laws and local regulations when disposing of detergents!

1. Drive to a suitable disposal centre.
2. Position the machine, ensuring the drain hose **Fig. 44-2** reaches the drain in the ground.
3. Turn the machine off and remove the key.
4. Remove the drain hose **Fig. 44-2** from the holder, open the drain valve and empty the waste water tank over the drain.
5. Ensure that the drain hose closure is fully closed after draining **Fig. 44-3!**
6. Stow away the drain hose in the holder again.

5.4.2 Cleaning the waste water tank

Clean the waste water tank as required but at least once a day.

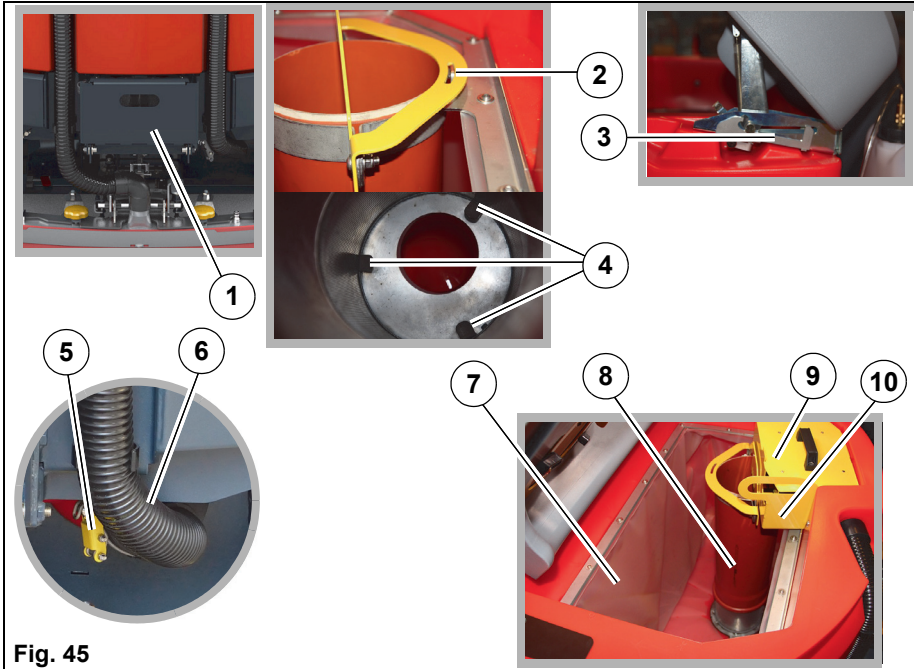

Fig. 45

- 1 Step
- 2 Top filter tube guide
- 3 Cap support
- 4 Bottom filter tube guide
- 5 Drain hose quick release
- 6 Waste water tank drain hose
- 7 Waste water tank
- 8 Filter tube
- 9 Coarse dirt sieve
- 10 Coarse dirt sieve holder

1. Empty the waste water tank, see section 5.4.1.
2. Pull up the step **Fig. 45-1** and swivel it to the rear.
3. Open the quick release **Fig. 45-5** and remove the drain hose **Fig. 45-6**.
4. Open the cap of the flex wall tank completely until the cap support engages **Fig. 45-3**.
5. Remove the coarse dirt sieve **Fig. 45-9** upwards, tip it out, clean it with water and put it aside.
6. Remove the holder **Fig. 45-10** of the coarse dirt sieve upwards, clean it with water and put it aside.
7. When the waste water tank is completely empty, remove the filter tube **Fig. 45-8** upwards and clean it with water.
8. Clean the waste water tank thoroughly with the water hose/spray nozzle **Fig. 45-7**.
9. Also flush the drain hose.
10. Reinsert the filter tube **Fig. 45-8**. Make sure that the bottom filter tube **Fig. 45-4** and the top filter tube **Fig. 45-2** are seated properly.
11. Insert the coarse dirt sieve holder **Fig. 45-10**.
12. Insert the coarse dirt sieve **Fig. 45-9**.
13. Open the cap of the flex wall tank as far as it will go. This unlocks the tank support **Fig. 45-3** and the tank cap can be closed.
14. Position the drain hose **Fig. 45-6** on the support of the maintenance opening and install it using the quick release **Fig. 45-5**.
The arrow on the connection support of the drain hose points upwards.

5.4.3 Cleaning the coarse dirt sieve

The flex wall tank is located in the coarse dirt sieve **Fig. 45-9**. Clean the sieve as required but at least once a day.

1. Open the cap of the flex wall tank until the cap support engages **Fig. 45-3**.
2. Remove the coarse dirt sieve **Fig. 45-9** upwards, tip it out, clean it with water and reinsert it.
3. Open the cap of the flex wall tank as far as it will go. This unlocks the tank support **Fig. 45-3** and the tank cap can be closed.

5.4.4 Cleaning the intake sieve

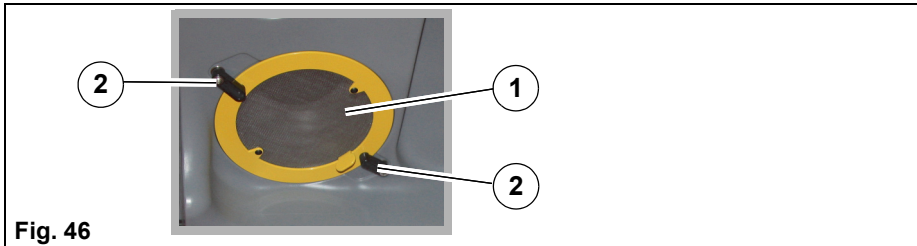

- 1 Intake sieve
- 2 Closures

Check the function of the intake sieve **Fig. 46-1** daily and clean it as required.

1. Open the cap of the flex wall tank completely until the cap support engages **Fig. 45-3**.
2. Unlock the closures **Fig. 46-2** while holding the intake sieve and then remove the intake sieve **Fig. 46-1**.
3. Thoroughly clean the intake sieve under running water.
4. Insert the intake sieve and lock it with the closures.
5. Open the cap of the flex wall tank as far as it will go. This unlocks the tank support **Fig. 45-3** and the tank cap can be closed.

5.4.5 Checking the seal at the drain valve

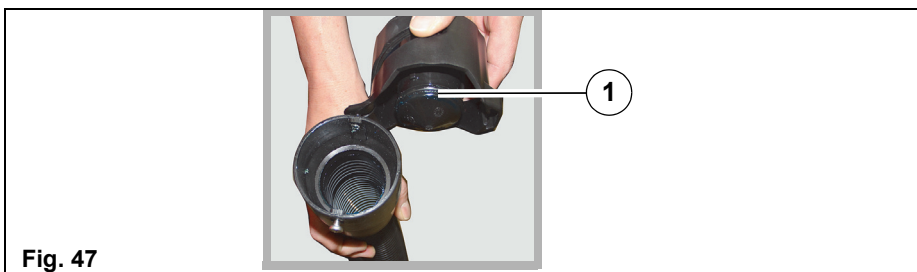

Check the function of the seal at the drain valve **Fig. 47-1** daily, replace it after 125 operating hours at the latest.

1. Twist drain valve by 90° and swivel down from drain hose.
2. Change the seal.
3. Grease the seal and cone with suitable grease, e.g. Molykote.

5.4.6 Cleaning and checking the seal in the tank cap

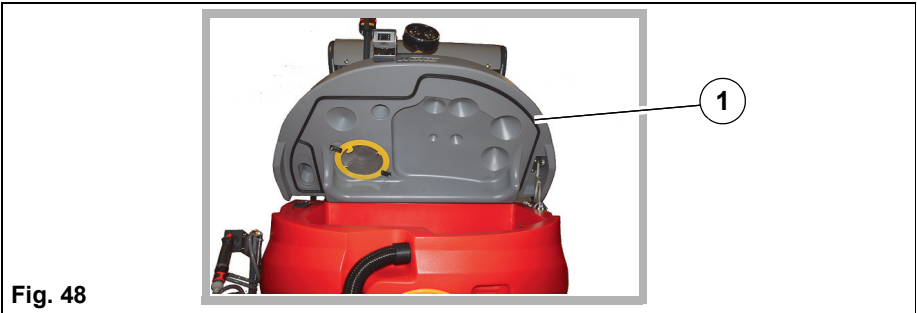

Fig. 48

Clean the seal **Fig. 48-1** in the tank cap daily and check it for proper functioning. In case of damage, have it replaced by a Hako service workshop.

5.5 Cleaning the fresh water filter

Check the filter sieve **Fig. 49-6** of the fresh water filter **Fig. 49-1** weekly and clean or replace it as required.

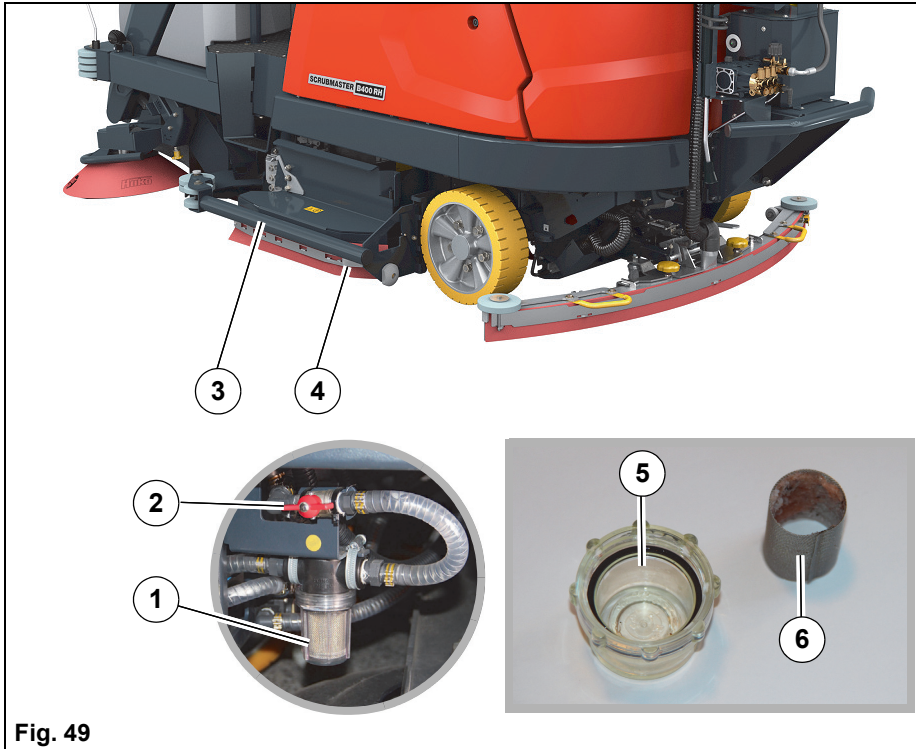

Fig. 49

- 1 Fresh water filter
- 2 Ball cock
- 3 Side collision protection (option)
- 4 Side wiper
- 5 Filter cap
- 6 Filter sieve

1. If present, unlock the side collision protection **Fig. 49-3** on the left side of the machine, raise it slightly and swivel it to the side.
2. Raise the side wiper **Fig. 49-4** on the left side of the machine and swivel it to the side.
3. Close the ball cock **Fig. 49-2**.
4. **Caution!**
Do not lose the seal in the filter cap.
Turn the filter cap **Fig. 49-5** anti-clockwise and remove it.
5. Remove the filter sieve **Fig. 49-6** from the filter housing and clean it under running water. Replace the filter sieve as required.
6. **Caution!**
Screw in the filter cap only hand-tight, otherwise the seal may be destroyed.
Insert the filter sieve into the filter cap and screw in the filter cap clockwise hand-tight.
7. Open the ball cock.
8. Swivel back the side wiper and hook it in.
9. If present, swivel back the side collision protection and hook it in.

5.6 Rotating brush unit

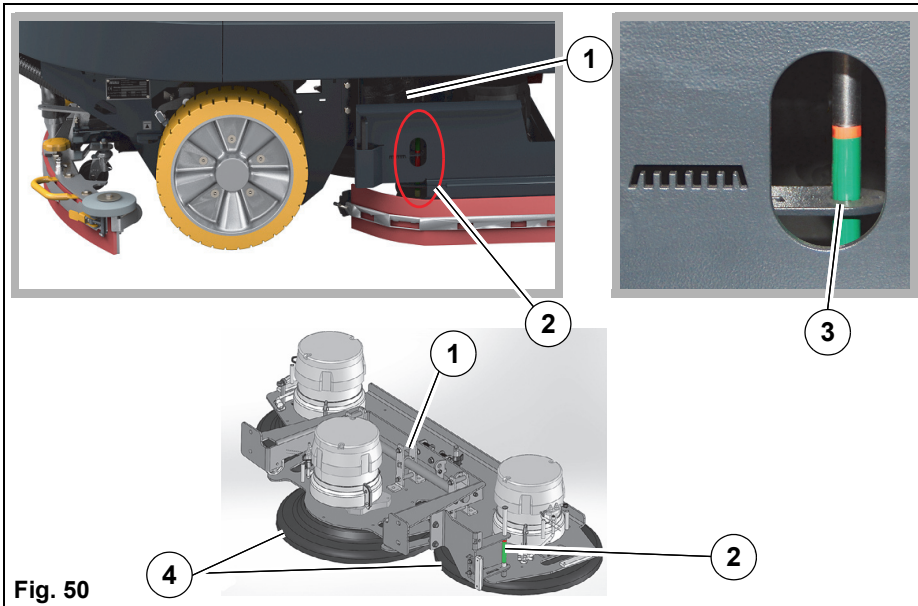

Fig. 50

- 1 Rotating brush unit
- 2 Indicator
- 3 Indicator marking
- 4 Rotating brushes

5.6.1 Changing the rotating brushes/pads



Attention

If the rotating brushes/pads are not fitted, there is a risk of material damage to the machine and ground.

Using the indicator **Fig. 50-2** on the right side of the machine, it is possible to:

- Determine the wear of the rotating brushes/pads (the rotating brush unit must be lowered)
- Determine whether the rotating brushes/pads have been fitted

The rotating brushes/pads **Fig. 50-4** must be changed at the latest when the indicator **Fig. 50-3** is in the red zone.



Note

If no rotating brushes/pads are fitted, the top edge of the display plate is outside the coloured area.

1. Decouple the rotating brushes/pads, see section 5.6.3.
2. Couple new rotating brushes/pads, see section 5.6.4.

5.6.2 Cleaning the rotating brushes

Check and clean the rotating brushes **Fig. 50-4** in the rotating brush unit **Fig. 50-1** as required but at least once a day.

1. Decouple the rotating brushes, see section 5.6.3.
2. Clean the rotating brushes thoroughly under running water, solid parts must be removed.
3. Couple the rotating brushes, see section 5.6.4.

5.6.3 Decoupling the rotating brushes/pads

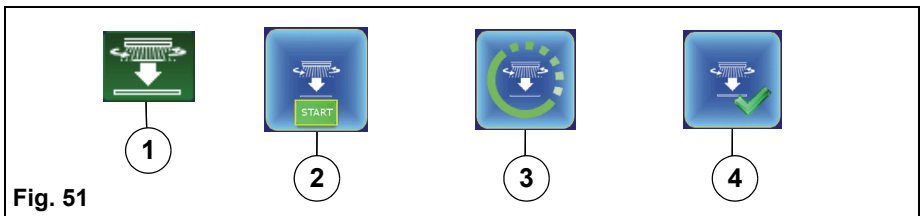

Fig. 51

- 1 Soft key *Decouple rotating brushes*
- 2 Start process *Decouple rotating brushes*
- 3 Process progress
- 4 Process *Decouple rotating brushes* completed

1. Make sure that the rotating brush unit has been raised and the machine is stationary.
2. Select the soft key *Decouple the brushes* **Fig. 51-1** using the turn-push knob and confirm.
The action window **Fig. 51-2** opens.
3. Use the turn-push knob to confirm the start.
The process starts and the multifunction display shows the following symbols one after the other **Fig. 51-3, 4**.
Only now has the process been completed.
4. If present, unlock the two side collision protection systems **Fig. 49-3** on both sides of the machine, raise them slightly and swivel them to the side.
5. Raise both side wipers **Fig. 49-4** on both sides of the machine and swivel them to the side.
6. Remove the rotating brushes/pads.

5.6.4 Coupling the rotating brushes/pads



Attention

In the case of rotating brushes that have been in use, there is a pre-tilt of the bristles (tufts of bristles are deformed and stand at an angle). It is important not to mix up the rotating brushes. The rotating brushes must be placed under the respective holder where they were before.



1



2



3



4

Fig. 52

- 1 Soft key *Couple rotating brushes*
- 2 Start process *Couple rotating brushes*
- 3 Process progress
- 4 Process *Couple rotating brushes* completed

1. Make sure that the rotating brush unit has been raised and the machine is stationary.
2. If present, unlock the two side collision protection systems **Fig. 49-3** on both sides of the machine, raise them slightly and swivel them to the side.
3. Raise both side wipers **Fig. 49-4** on both sides of the machine and swivel them to the side.
4. Place the rotating brushes/pads in a central position underneath the rotating brush unit holder. Then move another centimetre in the driving direction of the machine.
5. Select the soft key *Couple brushes* **Fig. 52-1** using the turn-push knob and confirm.
The action window **Fig. 52-2** opens.
6. Use the turn-push knob to confirm the start.
The process starts and the multifunction display shows the following symbols one after the other **Fig. 52-3, 4**. Only now has the process been completed.
7. Check whether the rotating brushes have been coupled. Also pay attention to unusual noises or vibrations.
8. Swivel back both side wipers and hook them in.
9. If present, swivel back the two side collision protection systems and hook them in.

5.7 Dirt hopper (B400 RM/RH only)



Warning

- Never exceed the permissible total weight and the permissible axle loads.
Check the filling level of the dirt hopper at regular intervals.



Attention

- The dirt hopper must be cleaned at regular intervals to prevent the accumulation of bacteria.

5.7.1 Emptying the dirt hopper (B400 RM only)

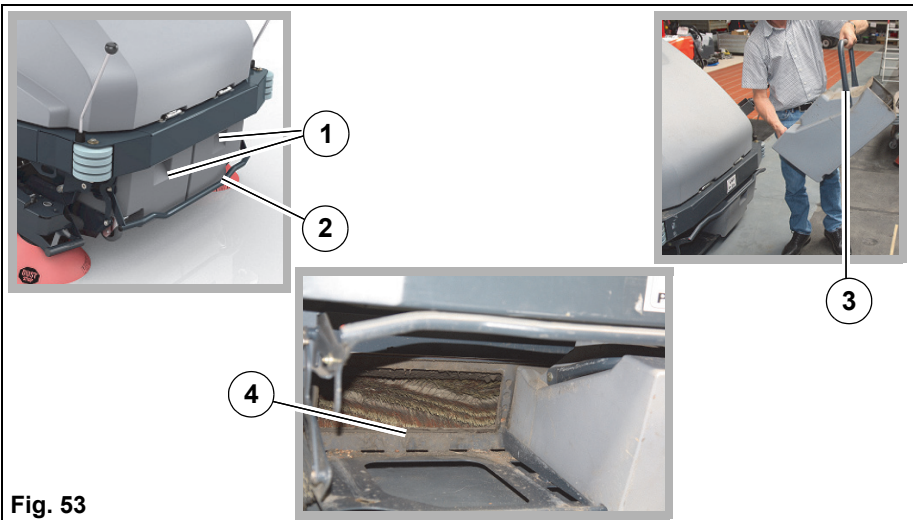

Fig. 53

- 1 Recessed grips of dirt hopper
- 2 Lock lever
- 3 Carrying handle
- 4 Sweeping roller compartment

Empty the dirt hopper at regular intervals.

1. Turn the machine off and remove the key.
2. Pull the lever **Fig. 53-2** for locking the dirt hopper upwards.
Both dirt hoppers are lowered to the ground.
3. Use the recessed grips to pull out the dirt hoppers **Fig. 53-1**.
4. Fold over the carrying handle and empty the dirt hoppers **Fig. 53-3**.
5. Check the sweeping roller and the sweeping roller compartment **Fig. 53-4** and clean if necessary.

Installation is in reverse order.

5.7.2 Emptying the dirt hopper (B400 RH)



Danger

- When raising and lowering the dirt hopper, there is a risk of crushing or shearing for nearby persons. Ensure a sufficient safety distance. When raising and lowering the dirt hopper, there must be no persons, animals or objects in the work area.
- For high dump of the dirt hopper, the machine must be parked on a level and solid surface.
- When the dirt hopper is raised, only drive at creep speed. Avoid abrupt steering movements or braking.



Warning

- Only tip out the contents of the dirt hopper from a possible low height in order to prevent the formation of dust.
- The dirt hopper may be raised only in the direct vicinity of the container.

Empty the dirt hopper at regular intervals.

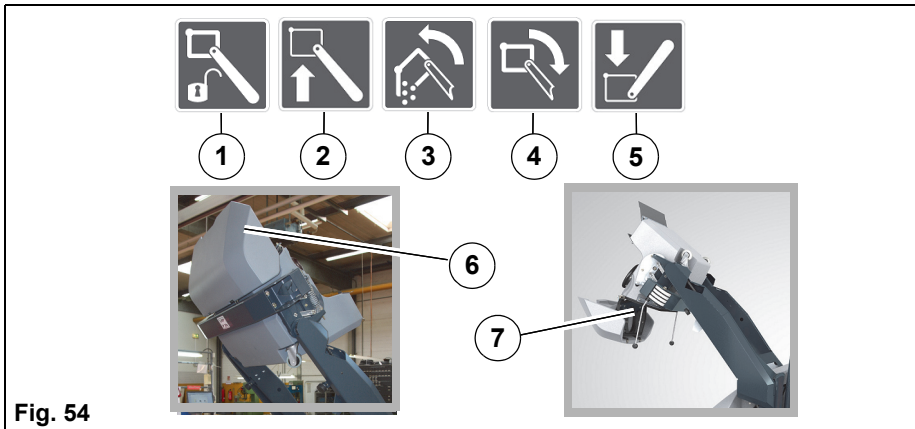

Fig. 54

- 1 Button *Unlock high dump*
- 2 Button *Raise dirt hopper*
- 3 Button *Empty dirt hopper*
- 4 Button *Straighten dirt hopper*
- 5 Button *Lower dirt hopper*
- 6 Dirt hopper raised
- 7 End position Empty dirt hopper

1. Drive to a suitable disposal centre.
2. Stop the machine near a container.
3. Raise the dirt hopper. To do this, press and hold the two buttons *Unlock high dump* **Fig. 54-1** and *Raise dirt hopper* **Fig. 54-2** on the control panel simultaneously until the desired position **Fig. 54-6** has been reached.
4. Release both buttons.
5. If necessary, carefully move the machine closer to the container and stop.
6. Empty the dirt hopper. To do this, press and hold the two buttons *Unlock high dump* **Fig. 54-1** and *Empty dirt hopper* **Fig. 54-3** on the control panel simultaneously until the end position **Fig. 54-7** has been reached.
The dirt hopper is emptied.
7. Straighten the dirt hopper again. To do this, press and hold the two buttons *Unlock high dump* **Fig. 54-1** and *Straighten dirt hopper* **Fig. 54-4** on the control panel simultaneously until the starting position **Fig. 54-6** has been reached.
8. Carefully move the machine away from the container and stop it.
9. Check the sweeping roller compartment and clean if necessary.
10. Lower the dirt hopper. To do this, press and hold the two buttons *Unlock high dump* **Fig. 54-1** and *Lower dirt hopper* **Fig. 54-5** on the control panel simultaneously until the end position has been reached.

5.8 Pre-sweep suction unit (B400 RM/RH only)



Attention

Work mode only permitted with inserted dirt hoppers (B400 RM) or completely lowered dirt hopper (B400 RH).

5.8.1 Changing the sweeping roller (B400 RM/RH only)

The sweeping roller must be changed at the latest when a sweeping roller diameter of 190 mm is reached or the star-shaped handle for adjusting the sweeping level has reached the stop.

1. Remove the sweeping roller, see section 5.8.3.
2. Insert the new sweeping roller, see section 5.8.4.
3. Adjust the sweeping level, see section 5.8.5.

5.8.2 Cleaning the sweeping roller and the sweeping roller compartment

Check the sweeping roller and sweeping roller compartment daily for dirt and clean if necessary.

1. Remove the sweeping roller, see section 5.8.3.
2. If necessary, remove straps and other packaging materials from the sweeping roller.
3. Thoroughly clean the sweeping roller under running water.
4. Clean the sweeping roller compartment.
5. Insert the sweeping roller, see section 5.8.4.

5.8.3 Removing the sweeping roller

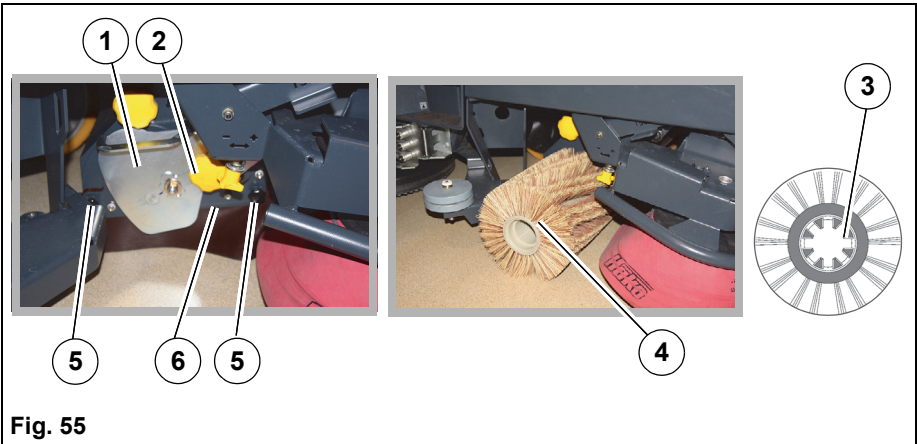

Fig. 55

- 1 Cover
- 2 Star-shaped handle (yellow)
- 3 Sweeping roller teeth
- 4 Sweeping roller
- 5 Star-shaped handle (black with yellow dot)
- 6 Plate with seal

1. Turn on the machine.
2. Start sweeping operation.
3. When the sweeping roller has been completely lowered, turn off the machine and remove the key.
4. Unscrew the yellow star-shaped handle **Fig. 55-2** on the right side of the machine and remove the cover **Fig. 55-1**.
5. Unscrew the two black star-shaped handles with the yellow dots **Fig. 55-5** and remove the plate with seal **Fig. 55-6**.
6. Pull out the sweeping roller **Fig. 55-4**.

5.8.4 Inserting the sweeping roller



Note

- Turn the star-shaped handle for sweeping level adjustment **Fig. 56-2** as far as it will go in the direction “-” (minus). This facilitates inserting the sweeping roller.
- Please ensure that the sweeping roller is in the correct installation position! The teeth point towards the left side of the machine.

1. Slide the new or cleaned sweeping roller with the toothed side **Fig. 55-3** into the sweeping housing and onto the driver of the opposite side.
2. Turn the sweeping roller several times to ensure the sweeping roller sits well on the teeth and the bristles lie optimally in the sweeping housing.
3. Insert the plate with seal **Fig. 55-6** and install it with the two black star-shaped handles with the yellow dots **Fig. 55-5**.
4. Fit the cover **Fig. 55-1** onto the sweeping roller and install it with the yellow star-shaped handle **Fig. 55-2**.
5. Adjust the sweeping level, see section 5.8.5.

5.8.5 Adjusting the sweeping level



2



Fig. 56

- 1 Button *Pre-sweep suction unit*
- 2 Sweeping level adjustment star-shaped handle



Note

To check the sweeping level, chalk a floor area measuring 1 m x 20 cm.

In the event of bristle wear and after changing the sweeping roller, the sweeping level must be readjusted.

1. Park the machine over the chalked area.
2. Turn on the machine and press the *Pre-sweep suction unit* button **Fig. 56-1**.
3. Let the sweeping roller rotate briefly while stationary.
4. Switch off sweeping operation, wait until the sweeping unit has been raised and drive off the marked area.
5. Check the sweeping level. If the adjustment is correct, a parallel-running sweeping level of approx. 50 +/- 10 mm must be marked on the ground.
 - If the sweeping level is correct, no further adjustment is required.
 - If the sweeping level is incorrect, proceed with the other steps.
6. Turn the machine off and remove the key.
7. Adjust the sweeping level with the star-shaped handle **Fig. 56-2**.
8. Repeat the process until the adjustment is correct.

5.9 Side broom (B400 RM/RH only)

5.9.1 Changing the side broom

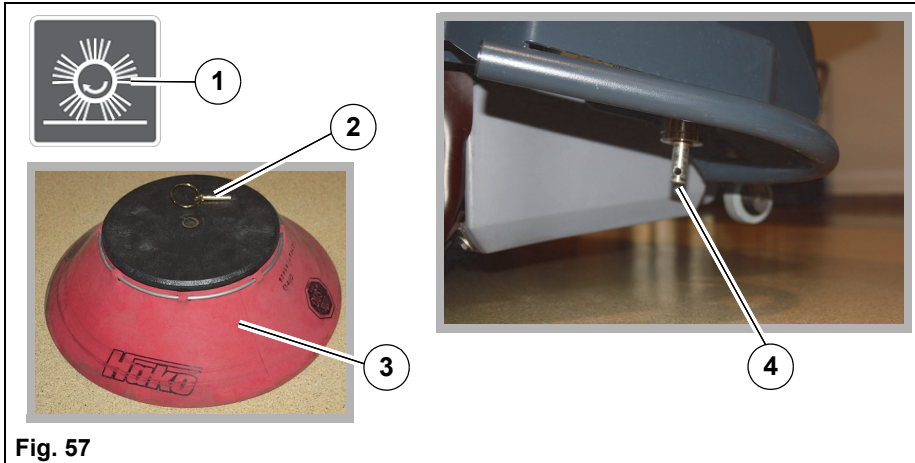

Fig. 57

- 1 Button *Pre-sweep suction unit*
- 2 Locking pin
- 3 Side broom with optional Dust Stop
- 4 Hub with hole

Inspect the side broom once per week and replace if wear is present.

1. Park the machine on a level surface.
2. Turn the machine off and remove the key.
3. Unlock and remove the locking pin **Fig. 57-2** located underneath the broom.
4. Remove the side broom **Fig. 57-3** downwards.
5. Fit the new side broom **Fig. 57-3**.
6. Insert the locking pin underneath the broom into the hole in the hub and lock it.

5.9.2 Adjusting the side broom

Side broom tilt

The tilt of the side broom is preset at the factory and cannot be changed.

Readjusting the side broom position

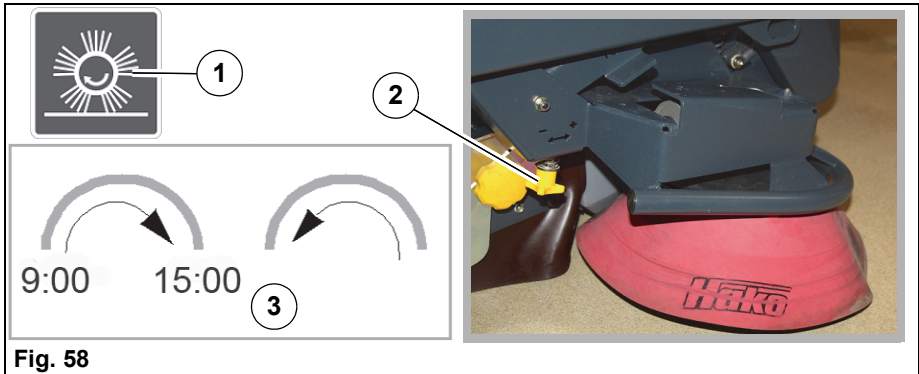

Fig. 58

- 1 Button *Pre-sweep suction unit*
- 2 Side broom position adjustment
- 3 Sweeping level



Note

To check the sweeping level, chalk a floor area measuring 50 cm x 50 cm.

The sweeping level must be readjusted if the event of bristle wear and after replacing the side brooms.

1. Park the machine over the chalked area.
2. Turn on the machine and press the *Pre-sweep suction unit* button **Fig. 58-1**.
3. Let the side broom rotate briefly while stationary.
4. Switch off sweeping operation, wait until the side broom has been raised and drive off the marked area.
5. Turn the machine off and remove the key.
6. Turn the yellow star-shaped handle **Fig. 58-2** until 1/2 of the area of the side broom is touching the floor. Compared to a clock lying on the floor, where the 12 is at the front in driving direction, the sweeping level **Fig. 58-3** must be marked on the floor from 9 to 3 o'clock.
7. Repeat the process until the adjustment is correct.

5.10 Filter system/Dust extraction system (B400 RM/RH only)

5.10.1 Cleaning the plate filter



Warning

Shaking the filter is only permitted with the dirt hopper inserted and closed.

Clean the plate filter multiple times per day using the agitator.

To clean the filter during operation, press the *Suction fan/Filter cleaning* button. The suction fan is switched off and several agitating intervals follow.

5.10.2 Basic cleaning of the plate filter



Danger

Health hazard!
Do not inhale the dust!
Wear a suitable dust mask.

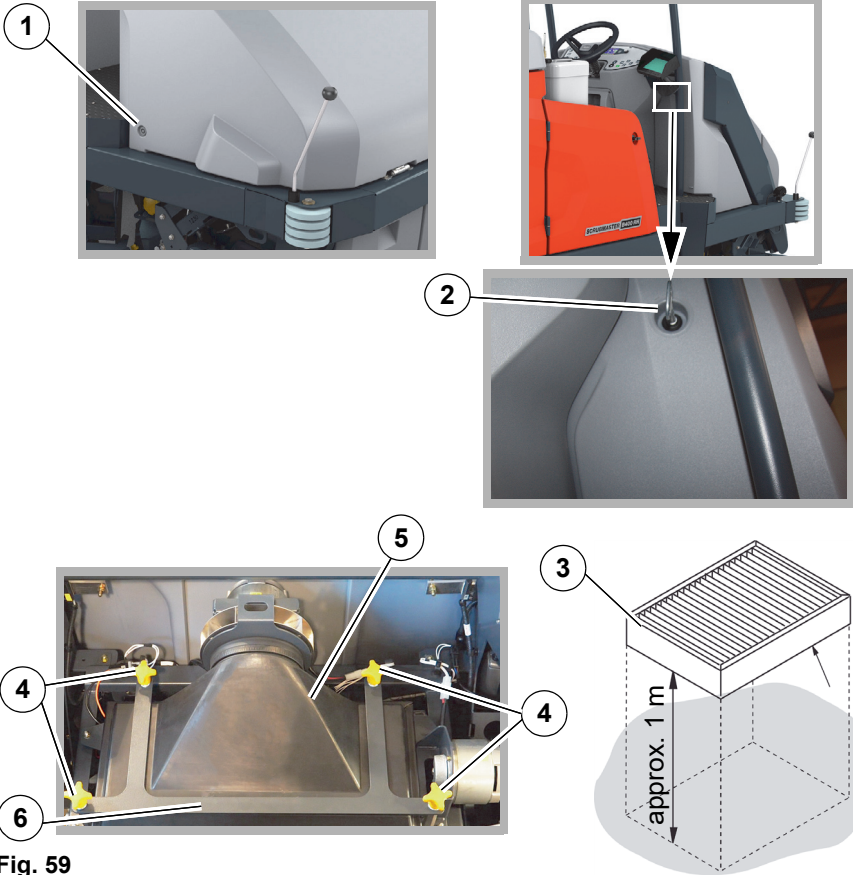

Fig. 59

- 1 Unlocking device of pre-sweep suction unit hood (B400 RM)
- 2 Unlocking device of pre-sweep suction unit hood (B400 RH)
- 3 Plate filter
- 4 Star-shaped handles
- 5 Filter hood
- 6 Mounting plate

1. Turn the machine off and remove the key.
2. Use the square key to unlock the pre-sweep suction unit hood on the right side **Fig. 59-1** (B400 RM) or to the right of the steering wheel **Fig. 59-2** (B400 RH).
3. Open the coarse material flap (B400 RH only).
4. Open the pre-sweep suction unit hood to the front.
5. Loosen the star-shaped handles **Fig. 59-4** and remove them together with the mounting plate **Fig. 59-6**.
6. Remove the filter hood **Fig. 59-5**.
7. Remove the plate filter.
8. Hold the plate filter horizontally approx. 1 m above the floor **Fig. 59-3** so that the dirty side faces the floor.
9. Drop the plate filter ensuring it is flat when reaching the floor.
10. If necessary, carry out this process several times.
11. The plate filter is installed in the reverse order.



Attention

Please ensure that the plate filter is in the correct installation position!
Markings can be found on the frame of the plate filter.

5.11 Squeegee

Optimum vacuuming is achieved through:

- Clean and undamaged or not worn sealing strips.
- Correctly set inclination angle and correct height adjustment of the squeegee.

5.11.1 Cleaning the squeegee

Check the squeegee **Fig. 60-4** daily for soiling and foreign particles and clean it as required.

Daily cleaning in the event of heavy soiling

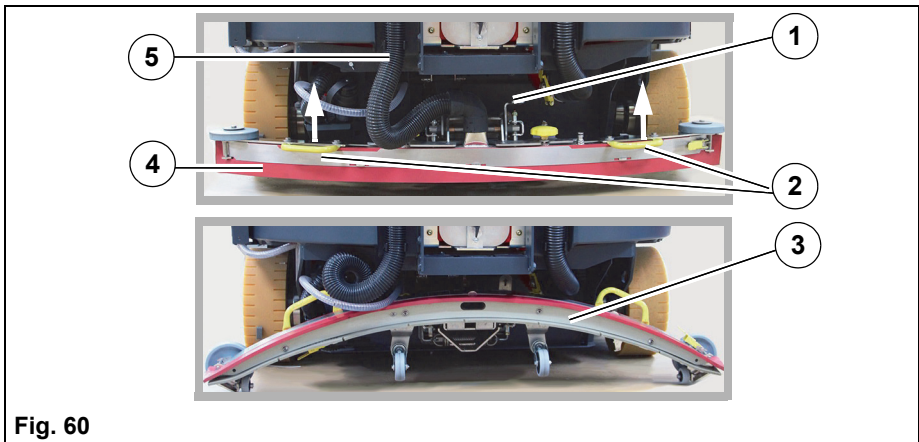

Fig. 60

- 1 Unlocking pedal
- 2 Handles
- 3 Squeegee folded over
- 4 Squeegee
- 5 Suction hose

1. Drive the machine to a suitable location with a drain in the floor.
2. Turn the machine off and ensure that the squeegee is in the raised position.
3. Pull out the suction hose **Fig. 60-5**.
4. Fold over the squeegee:
 - Actuate the unlocking pedal **Fig. 60-1**. Use the handle **Fig. 60-2** to fold over the squeegee against the stop **Fig. 60-3**.
5. Remove coarse dirt and clean the squeegee thoroughly using water. Check sealing strips for damage and replace if necessary.
6. Swivel the squeegee back and let it engage in its starting position.

Daily cleaning in the event of light soiling

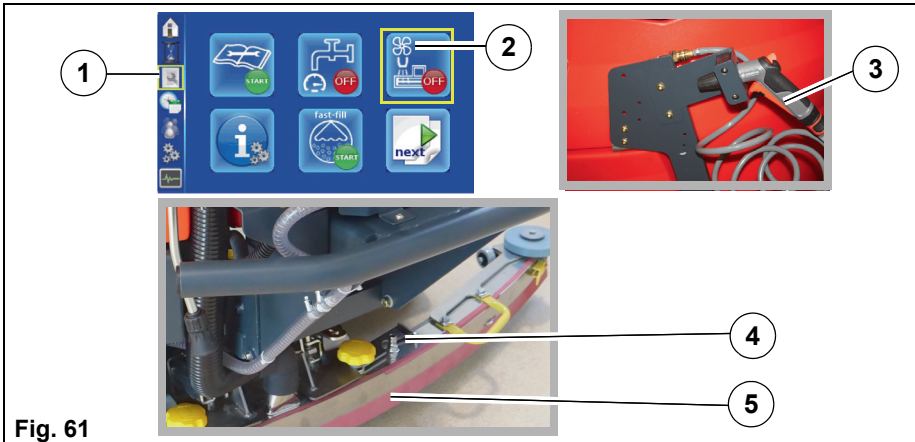

Fig. 61

- 1 Menu *Maintenance*
- 2 Soft key *Squeegee cleaning*
- 3 Spray nozzle (option)
- 4 Squeegee water connection
- 5 Squeegee

External water connection:

1. Sit on the seat of the machine and switch on the machine.
2. In the sub-menu, call up menu item *Maintenance Fig. 61-1*.
3. Select the soft key *Squeegee cleaning Fig. 61-2* with the turn-push knob and activate.

The squeegee is lowered and the suction is switched on. The remaining squeegee cleaning time is displayed in 5 second intervals.

4. Move the machine forward a little so that the sealing lips are tilted back.
5. Connect the hose to the connection of the squeegee **Fig. 61-5** using the 1/2" quick coupling, and to the water tap of the service connection.
6. Open the water tap all the way.
Squeegee is cleaned by the internal spray nozzles.
7. After the program has ended, close the water tap and remove the hose.

On-board water connection:

1. Disconnect the hose from the spray nozzle **Fig. 61-3** and attach to the squeegee connection **Fig. 61-5**.
2. Follow points 1 to 4 of section *External water connection*.
3. The squeegee is cleaned by the internal nozzles.
4. After the program has ended, remove the hose from the squeegee during the after-run time of the suction turbine and reconnect to the spray nozzle.



Attention

If the hose is not disconnected from the squeegee after the program has ended, the water may run out of the solution tank!

5.11.2 Changing the sealing / slot strip

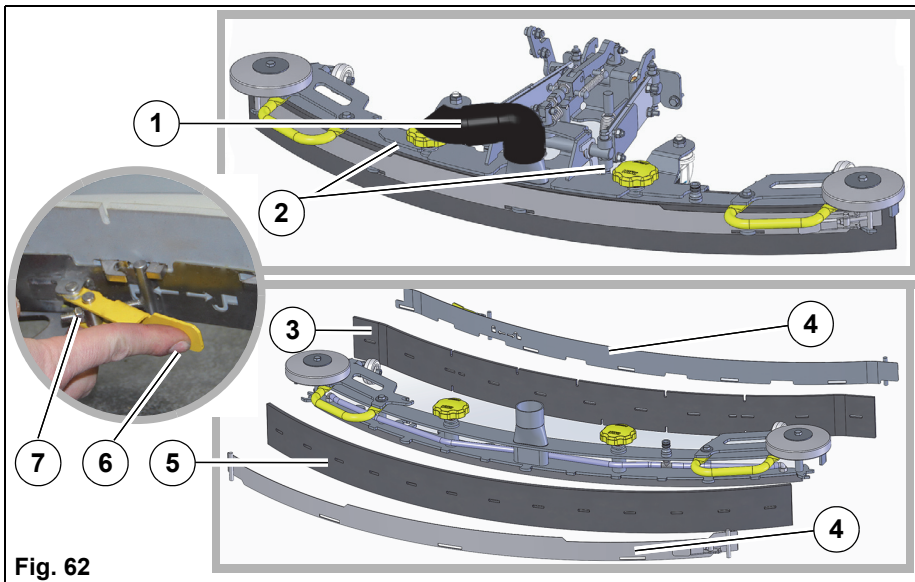

Fig. 62

- 1 Suction hose
- 2 Star-shaped handles
- 3 Slot strip
- 4 Tension strap
- 5 Sealing strip
- 6 Turnbuckle
- 7 Turnbuckle readjustment

Check the sealing strip **Fig. 62-5** and the slot strip **Fig. 62-3** at the squeegee daily for wear and damage. If the used sealing edge of the strip is worn or damaged, turn or replace the strip. Each strip can be used four times before it needs replacing.

1. Pull out the suction hose **Fig. 62-1**.
2. Loosen the star-shaped handles **Fig. 62-2** and remove the squeegee.
3. **Replacing the sealing strip:**

Release and remove the tension strap **Fig. 62-4**.

Replacing the slot strip:

Fold over the turnbuckle **Fig. 62-6** all the way when releasing so that the tension strap is easier to remove.

4. Remove the slot and sealing strip from the squeegee body.

- Before turning or replacing the slot and sealing strip, thoroughly clean the squeegee body!

Installation is in reverse order.



Note

The strips can be of different thickness. The turnbuckles must be readjusted if necessary **Fig. 62-7**.

5.12 Side wiper



Fig. 63

- Side wiper
- Wing nut
- Tension strap
- Wiper rubber

5.12.1 Changing the wiper rubber

Check the wiper rubber **Fig. 63-4** weekly for wear, turn or replace the rubber if necessary.

- Place the machine on a level surface.
- Turn the machine off and remove the key.
- If present, unlock the side collision protection **Fig. 49-3**, raise it slightly and swivel it to the side.
- Loosen the wing nut **Fig. 63-2**.
- Remove the tension strap **Fig. 63-3**.
- Turn the wiper rubber (can be used 4 times) or replace it.

Installation is in reverse order.

6 Attachments/options

6.1 Light refuse collector (B400 R only)

The light refuse collector consists of two waste bins and gripping/waste tongs. The waste bins are hooked onto the quick-connect system of the Scrubmaster B400 R and locked. Items can be picked up with the gripping/waste tongs and disposed of in the bins.

6.2 Broom strip (B400 R only)

The broom strip is hooked onto the quick-connect system of the Scrubmaster B400 R and locked. It can be used to push leaves, coarse dirt and other objects in front of the Scrubmaster in order to collect them in a separate place where they can be picked up manually.

6.3 Mop strip (B400 R only)

The mop strip is hooked onto the quick-connect system of the Scrubmaster B400 R and locked. It can be used to push fluff, fine dirt and other dirt in front of the Scrubmaster in order to collect them in a separate place where they can be picked up.

6.4 Spray suction tool

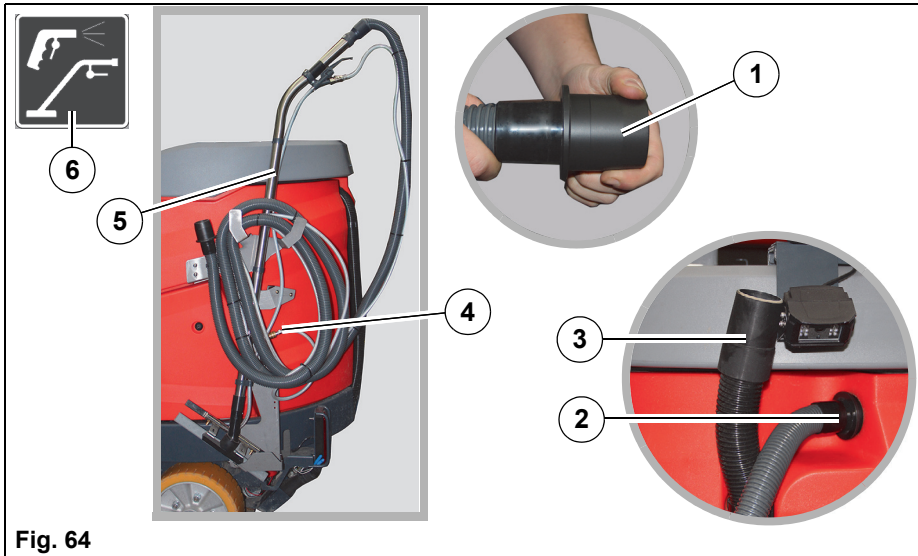

Fig. 64

- 1 Adapter
- 2 Vacuum system opening
- 3 Suction hose position
- 4 Water connection of machine
- 5 Spray suction tool
- 6 Button *Tool operation*

The spray suction tool **Fig. 64-5** is used for manually cleaning difficult-to-reach points.



Attention

- The spray suction tool is used to suck up dust. Only suck with the addition of water!
- Do not use the spray suction tool while driving!



Note

Before starting up for the first time, the provided adapter must be securely attached to the end of the hose **Fig. 64-1**.

1. Remove the suction hose **Fig. 64-3** from the vacuum system opening.
2. Insert the hose of the tool into the vacuum system opening **Fig. 64-2**.
3. Connect the hose to the water connection of the machine **Fig. 64-4**.

4. Use the *Tool operation* button **Fig. 64-6** on the control panel to switch the tool on and off. The operator must not be sitting on the seat.
Press the button twice: Spray suction tool ON
Press the button again: Spray suction tool OFF

6.5 Manual suction tool

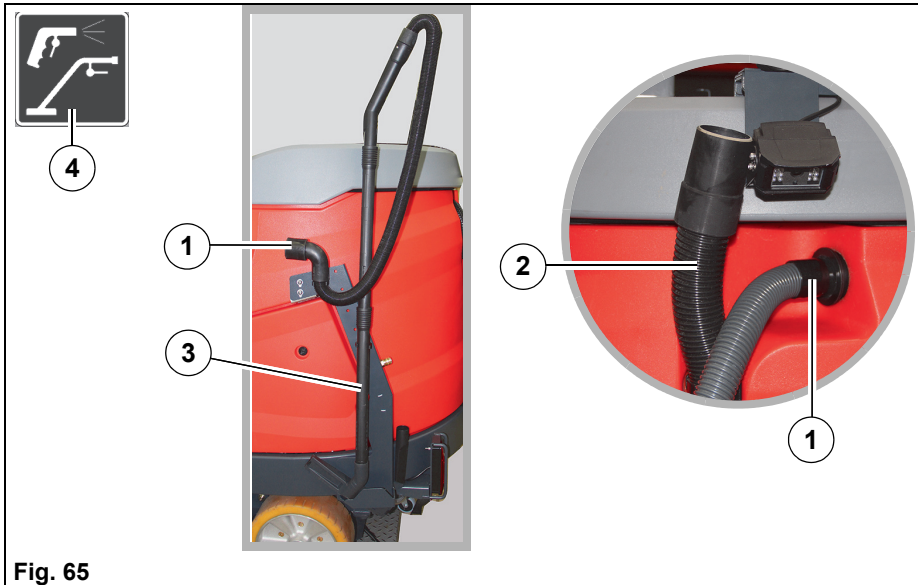

Fig. 65

- 1 Vacuum system opening
- 2 Suction hose park position
- 3 Manual suction tool:
- 4 Button *Tool operation*

The manual suction tool **Fig. 65-3** is used for manually cleaning difficult-to-reach points.



Attention

- The manual suction tool is not used to suck up dust. Only suck up water!
- Do not use the manual suction tool while driving!

1. Remove the suction hose from the vacuum system opening **Fig. 65-2**.
2. Insert the hose of the tool into the vacuum system opening **Fig. 65-1**.
3. Use the *Tool operation* button **Fig. 65-4** on the control panel to switch the tool on and off. The operator must not be sitting on the seat.
 Press the button twice: Manual suction tool ON
 Press the button again: Manual suction tool OFF

6.6 Spray nozzle

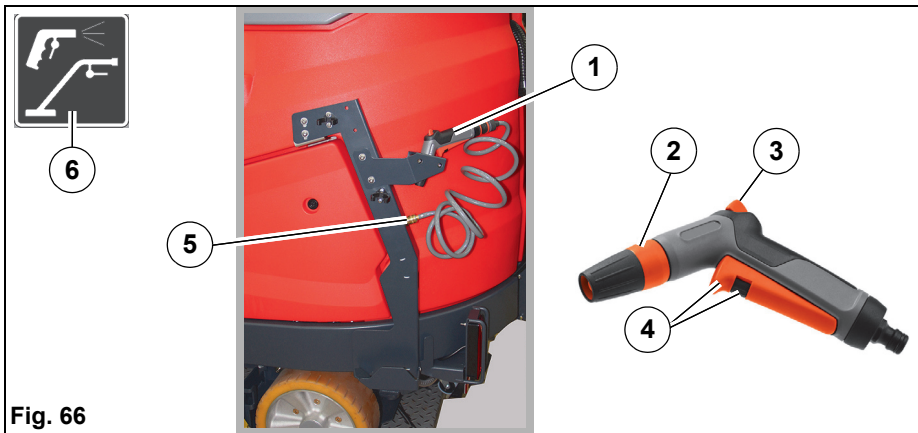

Fig. 66

- 1 Spray nozzle
- 2 Water jet type setting
- 3 Adjusting lever for water dosing
- 4 Operating handle ON / OFF water supply with locking mechanism
- 5 Water connection of machine
- 6 Button *Tool operation*

The spray nozzle **Fig. 66-1** is used to flush the waste water tank.

1. Connect the hose to the lateral water connection of the machine **Fig. 66-5**.
2. Use the *Tool operation* button **Fig. 66-6** on the control panel to turn the water supply on and off. The operator must not be sitting on the seat.
Press the button: Spray nozzle water supply ON
Press the button again: Spray nozzle water supply OFF
3. Spray nozzle operation:
 - 4 = Operating handle for switching the water supply with locking mechanism on and off
 - 3 = Adjusting lever for water dosing
 - 2 = Water jet type setting

6.7 Battery changing system

The battery changing system is an optional accessory for the Scrubmaster B400 R and is used exclusively for easy transport and changing of the battery. The battery changing system ensures that a charged battery is always available and can be changed at short notice if necessary. A hand pallet truck with a lifting height of 200 mm is also required.

Changing the battery



Warning

- Change the battery only on level ground, never on sloping or uneven ground.
- Wear safety shoes when changing the battery.
- Risk of crushing at the roller supports on the vehicle and on the battery changing rack.
Do not touch the roller supports on the vehicle and on the battery changing rack while the battery is moving!
- Risk of crushing when lifting and lowering the battery changing rack.
Do not reach between the lift truck and the battery changing rack when lifting!
Do not touch the contact surfaces!
When lowering the battery changing rack, keep sufficient distance to the feet of the battery changing rack!
- Risk of crushing while the battery is moving.
Do not stay in the battery changing rack while the battery is moving!



Attention

- When using other batteries which have been approved by Hako, the BMS must be reset to protect the battery against total discharge. The settings of the BMS must only be carried out by a Hako service workshop!
- Only use hand pallet trucks with a maximum lifting height of 200 mm, otherwise there is a risk of damage.



Note

When lowering the battery changing rack on the machine, apply pressure towards the machine so that the battery changing rack does not move away from the machine.

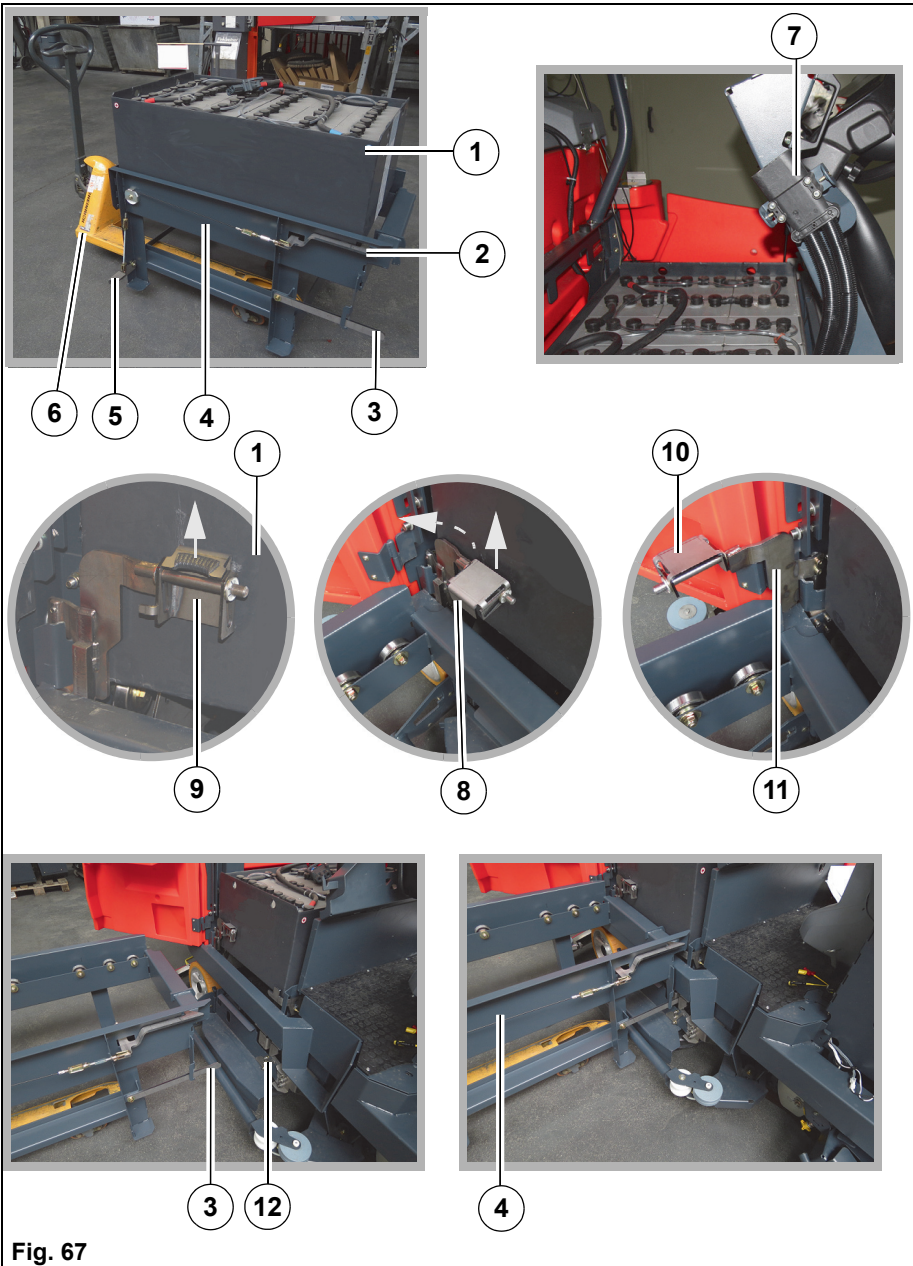

Fig. 67

- 1 Battery
- 2 Locking lever
- 3 Positioning aid
- 4 Battery changing rack
- 5 Foot lever unlocking device
- 6 Lift truck
- 7 Park position machine plug
- 8 Manually operated locking device of the battery in the machine
- 9 Manually operated locking device of the battery in the machine – closed
- 10 Pressure plate folded over 90°
- 11 Manually operated locking device of the battery in the machine – open
- 12 Slot in the vehicle frame

Removing the discharged battery

1. Park the vehicle on a level surface, turn it off and remove the key.
2. Unlock and open the right side door.
3. Fold up the seat console to the front.
4. Pull the machine plug out of the battery socket and hook it into the seat console **Fig. 67-7**.
5. Open the manually operated locking device **Fig. 67-9** of the battery **Fig. 67-1** in the machine. To do this, pull up the locking device on the handle as far as it will go and fold it over 90° to the rear of the machine **Fig. 67-11**.
6. With the lift truck fully raised (lifting height 200 mm) **Fig. 67-6** align the battery changing rack **Fig. 67-4** at right angles to the machine.
7. Thread the positioning aid **Fig. 67-3** on the left side of the battery changing rack into the slot in the machine frame **Fig. 67-12**.
8. Push the battery changing rack to the machine frame and place it on the ground using the lift truck. When lowering, make sure that the rack does not move away from the machine frame.
The automatic locking device of the battery in the machine is opened.
9. Pull the battery fully onto the battery changing rack.
Make sure that the locking lever **Fig. 67-2** closes fully.
10. Raise the battery changing rack using the lift truck to the maximum height of 200 mm.
11. Drive the discharged battery to the charging station and charge it, see section 5.2.2 *Charging the battery* on page 112.

Inserting the charged battery

1. Align the battery changing rack with the charged battery at right angles to the machine using the lift truck fully raised to 200 mm.
2. Repeat steps 7 and 8 in section *Removing the discharged battery*.
3. Operate the foot lever **Fig. 67-5** on the battery changing rack to unlock the battery and push the battery fully into the machine.
4. Close the manually operated locking device of the battery in the machine. To do this, raise the locking device and swivel it in the direction of the battery **Fig. 67-9**.
5. Raise the battery changing rack fully using the lift truck. The automatic locking device of the battery in the machine is closed.
6. Remove the battery changing rack from the machine.
7. Plug the machine plug into the battery socket.
8. Fold back the seat console.
9. Close and lock the right side door.

Maintaining the battery changing system

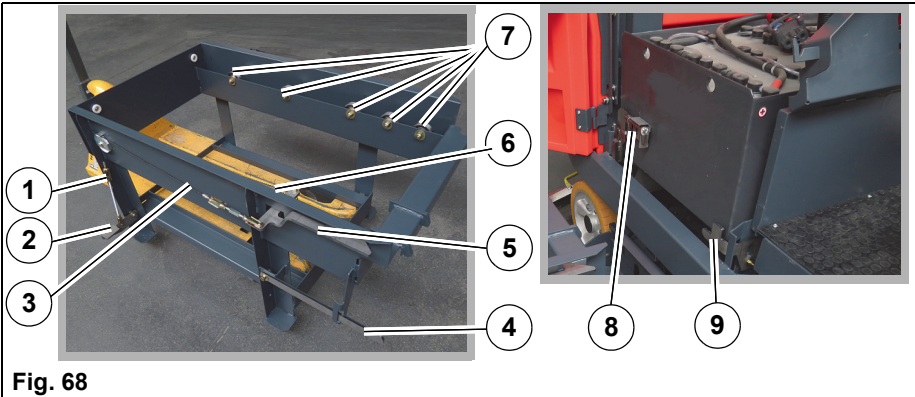

Fig. 68

- 1 Threaded rod
- 2 Foot lever, incl. locking lever
- 3 Rope
- 4 Positioning aid
- 5 Locking lever
- 6 Tension spring
- 7 Rollers
- 8 Manually operated locking device of battery in the machine
- 9 Automatic locking device of battery in the machine



Note

In case of damage or deformation as well as non-functioning components, contact your Hako service workshop or Hako customer service.

Functional check

The foot control for unlocking the battery and the associated locking lever must be checked weekly.

1. Raise the battery changing rack using the lift truck.
The locking lever blocks the foot control **Fig. 68-2**.
2. Place the battery changing rack on the ground.
The locking lever releases the foot lever.
3. Actuate the foot lever.
The locking lever is opened.
4. Release the foot lever.
The locking lever is moved to the home position by spring force.

6.8 Overhead guard

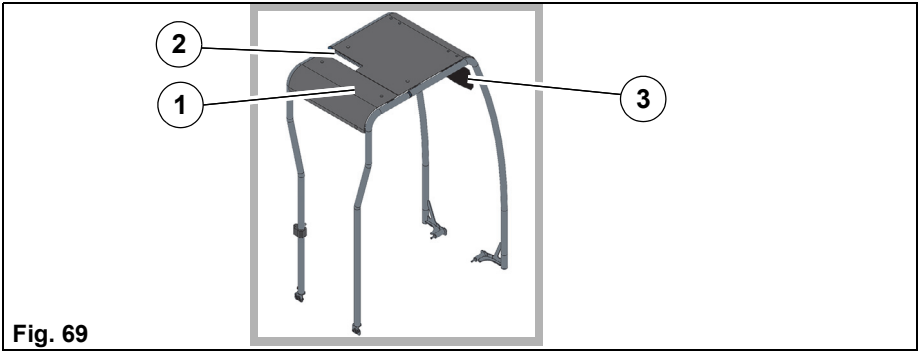

Fig. 69

- 1 Overhead guard
- 2 Recess for lifting equipment chain when changing the battery
- 3 Side mirror (option)

The overhead guard **Fig. 69-1** is used to protect the driver from falling parts in the high bay warehouse, for example.

An optional side mirror **Fig. 69-3** is available.

6.9 BlueSpot



Danger

Possible eye injury!

- Avoid looking directly at the light. Make sure in particular that children always follow this safety advice.
- Never adjust the set angle of the BlueSpot.



Fig. 70

The BlueSpot **Fig. 70-1** is a visual warning device. A blue spot projected onto the ground warns people and vehicles of approaching machines. In addition, an acoustic warning can be switched on when reversing, see section *Action level* on page 54.

6.10 Reversing camera

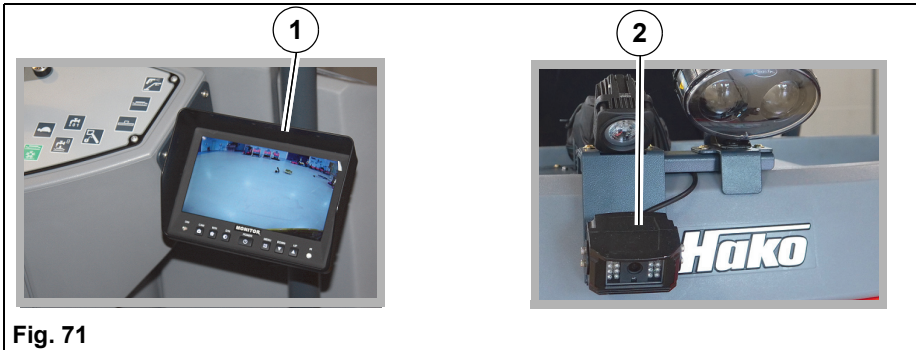

- 1 Monitor
- 2 Reversing camera

The reversing camera **Fig. 71-2** transmits an image of the rear working area onto the monitor **Fig. 71-1** to the right of the steering wheel. This way, the rear working area can be seen and obstacles detected more easily.

6.11 StVZO

The StVZO machine variant allows driving on public roads and areas, e.g. to get from one car park to the next. The lighting must be switched on during transport, when cleaning and moving. The speed of the StVZO variant is limited to 8 km/h when driving forwards and 4 km/h when reversing.

Registration

The Scrubmaster B400 R is a self-propelled working machine as defined by the StVZO. The manufacturer will provide an expert opinion for obtaining the operation licence. Based on this expert opinion, the local licensing authorities will produce the operation licence.

An official licence plate is not required. Regular general inspection in accordance with Section 29 StVZO is also not required, as the maximum specified speed is less than 20 km/h. In other countries, the corresponding national regulations must be complied with.

Driving license

A class L driving licence is required to drive the Scrubmaster B400 R (self-propelled machine up to 25 km/h). In other countries, the corresponding national regulations must be complied with.

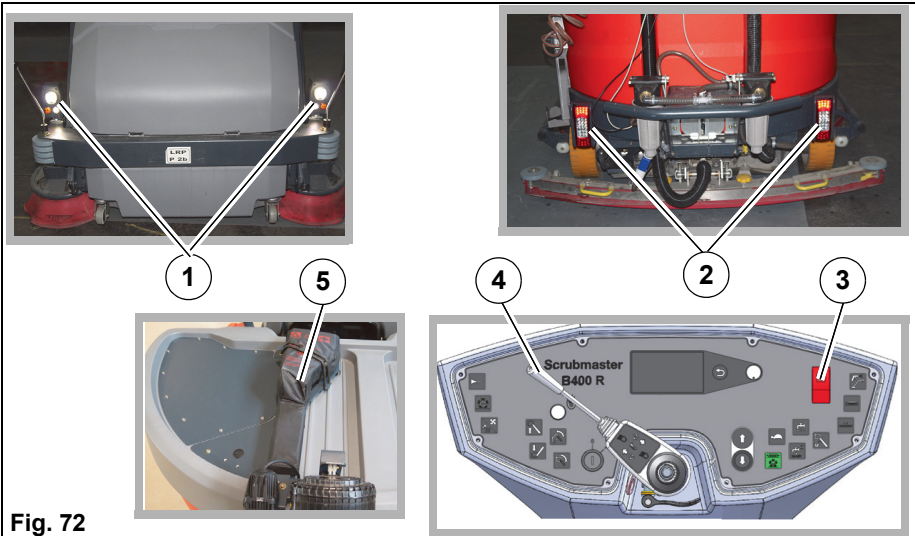
**Fig. 72**

- 1 Front lighting system
- 2 Rear lighting system
- 3 Hazard warning flasher switch
- 4 Steering column switch
- 5 First aid kit and warning triangle

When the ignition is turned on, the steering column switch **Fig. 72-4** has the following functions:

- Lever forwards (parallel to the control panel): Turn indicator (right)
- Lever backwards (parallel to the control panel): Turn indicator (left)
- Lever downwards (towards the control panel): Front dipped headlights and rear light
- Lever upwards (towards the steering wheel): Headlight flasher
- Press the steering column switch: Horn (in addition to the button on the control panel)

In the StVZO version, the brake lights light up when the brake button is pressed or when the driving speed is decelerated with the accelerator pedal. The hazard warning system is switched on and off by the switch on the control panel **Fig. 72-3**.

6.12 High-pressure cleaner

The high-pressure cleaner is an optional accessory for the Scrubmaster. This device is intended exclusively for performing all of common cleaning tasks, e.g. cleaning stairs, steps, corners, edges and small elevated surfaces that cannot be reached with the machine.

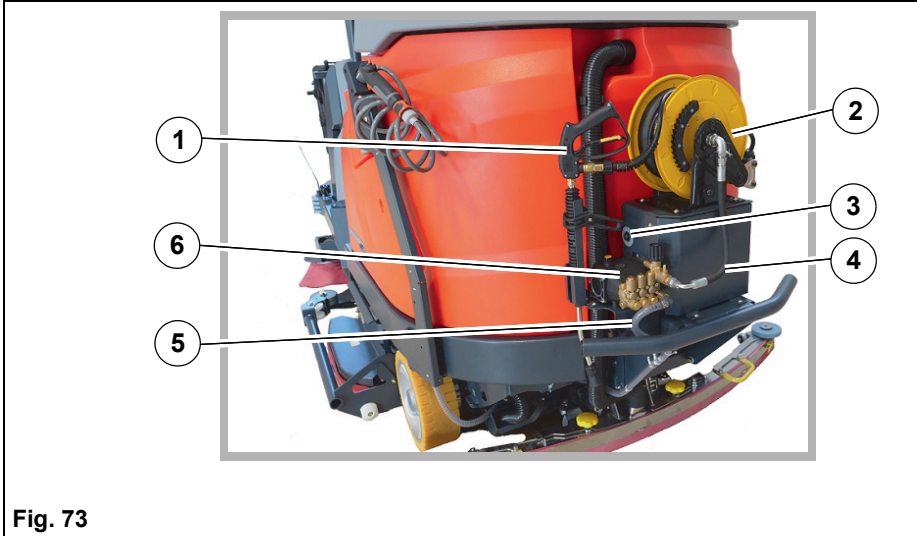

Fig. 73

- 1 High-pressure lance with manual control
- 2 Hose on reel
- 3 On/Off button
- 4 Pressure line
- 5 Supply of high-pressure cleaner from solution tank
- 6 High-pressure cleaner unit

**Warning**

- Before undertaking servicing and maintenance work, read and observe the safety instructions in chapter 1 of this operating manual!
- There is a risk of injury!
The jet of the high-pressure cleaner must not be directed at persons.
- Do not use high-pressure cleaners for cleaning electrical/ electronic components or the machine.
- Only use suitable extension lines approved by the manufacturer. If an extension hose is used, the plug and coupling must be water-tight.
- Use the high-pressure lance only when standing on a firm surface, e.g. not on ladders or from the driver's seat.
- The maximum operating pressure set by the manufacturer must not be increased.
- Use only with the machine at standstill and the parking brake applied.
- Make sure that no unauthorised person is on or near the machine while working with the high-pressure cleaner.
- Depressurise pressurised parts (hoses, etc.) when taking the machine out of service and before maintenance work.
- Never use the high-pressure cleaner with an empty solution tank.
- In winter with danger of frost, drain the water completely out of the high-pressure cleaner.
- Turn the machine off, remove the key and disconnect the battery plug when cleaning and maintaining the machine and before replacing parts.

**Note**

Continuous operation of the high-pressure cleaner should not exceed a period of 10 minutes.

Before putting into service

1. Top up the solution tank, see section 5.3.1 *Filling the solution tank* on page 121.
2. Drive the machine to the work site.
3. Stop the machine, the parking brake engages automatically.
4. Check whether the ball cock **Fig. 4-8** is open.

Cleaning

1. Press the button **Fig. 73-3** at the high-pressure cleaner.
The LED in the button lights up.
2. Clean the work site.
3. Press the button at the high-pressure cleaner.
The LED in the button goes out.
4. Press the high-pressure lance **Fig. 73-1** again to release the pressure.

Troubleshooting

No pressure present

- Check the spray nozzle in the lance, replace if necessary.
- Check all hoses, screw connections and components for leaks.
- Inform the Hako service workshop and have the problem eliminated.

EC Declaration of Conformity

Hako GmbH
Hamburger Str. 209-239
23843 Bad Oldesloe, Germany

declare in sole responsibility that the following products

Scrubmaster B400 R, RM, RH Model: 7190

to which this declaration relates correspond with the relevant basic safety and health requirements of EC Directive 2006/42/EC as well as the requirements according to 2014/30/EC and 2014/53/EC.

The following standard(s) and technical specifications was/were referred to for the correct implementation of the safety and health requirements named in the EC Directive:

EN 60335-2-72
EN 55012
EN 61000-6-2

Name of the authorised person who compiles the technical documents for Hako:
Ludger Lüttel

Bad Oldesloe, 22.02.2021



Ricardo Ruiz Porath
Product line manager – cleaning technology



Hako GmbH
Head Office
Hamburger Str. 209-239
23843 Bad Oldesloe
Germany
Tel. +49 4531 806-0
info@hako.com
www.hako.com